



# ENDURANCE

*Complete Solutions*



## PARTS CATALOGUE

⇒ BEST QUALITY ⇒ LONGEST DURABILITY ⇒ HIGHEST RELIABILITY

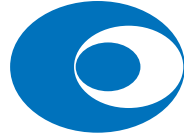

**ENDURANCE**

*Complete Solutions*

# **PARTS CATALOGUE**

**W.E.F. 01 FEB. 2023**

---

## **ENDURANCE TECHNOLOGIES LTD.**

### **Aftermarket Division**

E-94, M.I.D.C., Industrial Area, Waluj, Aurangabad - 431 136

Tel: +91 240 2569600 Fax: +91 240 2569703

Web: [www.endurancegroup.com](http://www.endurancegroup.com)

Mail: [marketing@endurance.co.in](mailto:marketing@endurance.co.in)

Customer Care Cell: [customercare@endurance.co.in](mailto:customercare@endurance.co.in)

# Endurance's presence in 150cc & above 150cc Motorcycles

KTM  
HUSQVARNA 701



Front : Inverted Fork  
Rear : Mono tube Mono shox

HARLEY DAVIDSON



Front : Telescopic Fork  $\phi$ 37mm  
Rear : Twin Hydraulic Cushion

HARLEY DAVIDSON  
Street Rod 750



Front : Inverted Fork  $\phi$ 43mm  
Rear : Twin Gas Shox

# Endurance's presence in 150cc & above 150cc Motorcycles

**KTM**  
Models : DUKE 200, 390, 690, 790, RC 200, RC 390



Front : Up-Side Down Fork  $\phi$ 43 mm  
Rear : Mono tube Mono shox  $\phi$ 14mm

**ROYAL ENFIELD**  
Models : Thunderbird 350/500, Classic 500, Bullet 350/500/Electra



Front : Telescopic Fork  $\phi$ 35 mm  
Rear : Twin Canister Shox

**KAWASAKI HEAVY INDUSTRIES** Models : Ninja 300, ER 250



Front : Telescopic fork  $\phi$ 37 mm  
Rear : Mono/ Twin tube Mono shox  $\phi$ 12.5mm

# Endurance's presence in 150cc & above 150cc Motorcycles

**SUZUKI MOTORCYCLES INDIA**  
Models : GIXXER SF, GIXXER



Front : Telescopic Fork  $\phi$ 41 mm  
Rear : Twin-tube Mono shox  $\phi$ 12.5mm

**MAHINDRA & MAHINDRA** Models : Mojo (300cc)



Front : Up-Side Down Fork  $\phi$ 37 mm

**BAJAJ AUTO LTD**

Avenger 150/220



Front : Telescopic Fork  $\phi$ 33mm  
Rear : Twin tube Hydraulic shox

Pulsar 150/180/200/220



Front : Telescopic Fork  $\phi$ 37/ 43 mm  
Rear : Mono shox with Canister

# Suspension

## Shock Absorbers



Spring Varieties  
Shock Absorbers



Hydraulic Shock Absorbers



Gas Filled Shock Absorbers  
**2 Wheeler Shock Absorbers**

# SHOCK ABSORBERS

## 3 WHEELER SHOCK ABSORBERS



**ENDURANCE**  
Complete Solutions



**PART NO. :** S130102707  
**APPLICATION :** SHOCK ABSORBER FRONT  
**SUITABLE FOR :** BAJAJ-GC 1000  
**STD. PACK :** 12



**PART NO. :** S260100607  
**APPLICATION :** SHOCK ABSORBER REAR  
**SUITABLE FOR :** BAJAJ GC 1000 (OLD)  
**STD. PACK :** 6



**PART NO. :** S301002010  
**APPLICATION :** SHOCK ABSORBER REAR  
**SUITABLE FOR :** BAJAJ GC 1000 (NEW)  
**STD. PACK :** 12



**PART NO. :** S135100607  
**APPLICATION :** SHOCK ABSORBER FRONT (ANTI DIVE-OLD)  
**SUITABLE FOR :** BAJAJ 2 STROKE / 4STROKE  
**STD. PACK :** 12



**PART NO. :** S130105107  
**APPLICATION :** SHOCK ABSORBER FRONT (ANTI DIVE-NEW)  
**SUITABLE FOR :** BAJAJ 2 STROKE / 4STROKE  
**STD. PACK :** 12



**PART NO. :** S230100401  
**APPLICATION :** SHOCK ABSORBER FRONT  
**SUITABLE FOR :** BAJAJ 2 STROKE / 4STROKE (205-X-RR)  
**STD. PACK :** 12



**PART NO. :** S260100807  
**APPLICATION :** SHOCK ABSORBER REAR - PLASTIC DUST COVER  
**SUITABLE FOR :** BAJAJ 2 STROKE / 4STROKE  
**STD. PACK :** 12



**PART NO. :** S265100406  
**APPLICATION :** SHOCK ABSORBER REAR - METAL DUST COVER  
**SUITABLE FOR :** BAJAJ 2 STROKE / 4STROKE  
**STD. PACK :** 12



**PART NO. :** S130109207  
**APPLICATION :** SHOCK ABSORBER FRONT  
**SUITABLE FOR :** BAJAJ DIESEL CARGO  
**STD. PACK :** 6



**PART NO. :** S265100606  
**APPLICATION :** SHOCK ABSORBER REAR  
**SUITABLE FOR :** BAJAJ DIESEL CARGO (OLD)  
**STD. PACK :** 12



**PART NO. :** S260100907  
**APPLICATION :** SHOCK ABSORBER REAR  
**SUITABLE FOR :** BAJAJ DIESEL CARGO (UPG)  
**STD. PACK :** 12



**PART NO. :** S301001010  
**APPLICATION :** SHOCK ABSORBER REAR  
**SUITABLE FOR :** BAJAJ DIESEL CARGO (NEW)  
**STD. PACK :** 12



**PART NO. :** S30101001M  
**APPLICATION :** SHOCK ABSORBER REAR  
**SUITABLE FOR :** BAJAJ MAXIMA  
**STD. PACK :** 12



**PART NO. :** S30100401M  
**APPLICATION :** SHOCK ABSORBER REAR  
**SUITABLE FOR :** BAJAJ CARGO  
**STD. PACK :** 6



**PART NO. :** S30100301M  
**APPLICATION :** SHOCK ABSORBER FRONT  
**SUITABLE FOR :** BAJAJ CARGO  
**STD. PACK :** 12



**PART NO. :** S9HT00575M  
**APPLICATION :** REAR OUTER SPRING  
**SUITABLE FOR :** BAJAJ 2 STROKE / 4STROKE  
**STD. PACK :** 12

# SHOCK ABSORBERS



**ENDURANCE**  
Complete Solutions

## 3 WHEELER SHOCK ABSORBERS



**PART NO. :** S255100106  
**APPLICATION :** SHOCK  
ABSORBER FRONT  
**SUITABLE FOR :** TVS-KING  
**STD. PACK :** 12



**PART NO. :** S265101107  
**APPLICATION :** SHOCK  
ABSORBER REAR  
**SUITABLE FOR :** TVS-KING  
**STD. PACK :** 6



**PART NO. :** S95102101M  
**APPLICATION :** SHOCK  
ABSORBER FRONT  
**SUITABLE FOR :** PIAGIO  
APE CITY  
**STD. PACK :** 12



**PART NO. :** S95102001M  
**APPLICATION :** SHOCK  
ABSORBER FRONT  
**SUITABLE FOR :** PIAGIO  
APE LD  
**STD. PACK :** 6



**PART NO. :** S130106506  
**APPLICATION :** SHOCK  
ABSORBER FRONT  
**SUITABLE FOR :** PIAGIO-APE  
**STD. PACK :** 6



**PART NO. :** S130106606  
**APPLICATION :** SHOCK  
ABSORBER REAR  
**SUITABLE FOR :** PIAGIO-APE  
**STD. PACK :** 12

## QUADRICYCLE (QUTE) SHOCK ABSORBERS



**PART NO. :** 1240114906  
**APPLICATION :** SHOCK  
ABSORBER FRONT  
**SUITABLE FOR :** BAJAJ  
QUTE (RE60)  
**STD. PACK :** 2



**PART NO. :** 1240115006  
**APPLICATION :** SHOCK  
ABSORBER REAR  
**SUITABLE FOR :** BAJAJ  
QUTE (RE60)  
**STD. PACK :** 2



# SHOCK ABSORBERS

## SCOOTER SHOCK ABSORBERS



**ENDURANCE**  
Complete Solutions



**PART NO. :** S125100312  
**APPLICATION :** SHOCK ABSORBER FRONT - LH  
**SUITABLE FOR :** HONDA ACTIVA 100/110, DIO  
**STD. PACK :** 20



**PART NO. :** S125100412  
**APPLICATION :** SHOCK ABSORBER FRONT - RH  
**SUITABLE FOR :** HONDA ACTIVA 100/110, DIO  
**STD. PACK :** 20



**PART NO. :** S135104212  
**APPLICATION :** SHOCK ABSORBER REAR  
**SUITABLE FOR :** HONDA ACTIVA 100/110, DIO  
**STD. PACK :** 12



**PART NO. :** S135104712  
**APPLICATION :** SHOCK ABSORBER  
**SUITABLE FOR :** HONDA ACTIVA 125 BS VI  
**STD. PACK :** 12



**PART NO. :** S125100112  
**APPLICATION :** SHOCK ABSORBER FRONT  
**SUITABLE FOR :** KINETIC-STYLE  
**STD. PACK :** 12



**PART NO. :** S95100201M  
**APPLICATION :** SHOCK ABSORBER REAR  
**SUITABLE FOR :** HERO PLEASURE  
**STD. PACK :** 12



**PART NO. :** S135104107  
**APPLICATION :** SHOCK ABSORBER REAR  
**SUITABLE FOR :** LML-VESPA  
**STD. PACK :** 12



**PART NO. :** S115101507  
**APPLICATION :** SHOCK ABSORBER ANTI DRIVE FRONT  
**SUITABLE FOR :** BAJAJ CHETAK  
**STD. PACK :** 12



**PART NO. :** S135100207  
**APPLICATION :** SHOCK ABSORBER FRONT  
**SUITABLE FOR :** BAJAJ SCOOTER  
**STD. PACK :** 25



**PART NO. :** S135100307  
**APPLICATION :** SHOCK ABSORBER REAR  
**SUITABLE FOR :** BAJAJ SCOOTER  
**STD. PACK :** 12



**PART NO. :** S135101007  
**APPLICATION :** SHOCK ABSORBER REAR  
**SUITABLE FOR :** TVS SCOOTY  
**STD. PACK :** 12



**PART NO. :** S135106407  
**APPLICATION :** SHOCK ABSORBER REAR  
**SUITABLE FOR :** TVS SCOOTY PEP  
**STD. PACK :** 12



**PART NO. :** S95105401M  
**APPLICATION :** SHOCK ABSORBER SET  
**SUITABLE FOR :** HONDA ACTIVA  
**STD. PACK :** 20 SET



**PART NO. :** S95103001M  
**APPLICATION :** SHOCK ABSORBER REAR  
**SUITABLE FOR :** TVS-JUPITER  
**STD. PACK :** 12



**PART NO. :** S95101601M  
**APPLICATION :** SHOCK ABSORBER REAR  
**SUITABLE FOR :** SUZUKI ACCESS  
**STD. PACK :** 12



**PART NO. :** S95104401M  
**APPLICATION :** SHOCK ABSORBER  
**SUITABLE FOR :** YAMAHA FASCINO  
**STD. PACK :** 12 SET

# SHOCK ABSORBERS

## MOTORCYCLE SHOCK ABSORBERS



**ENDURANCE**  
Complete Solutions



**PART NO. :** S130106903  
**APPLICATION :** SHOCK ABSORBER REAR  
**SUITABLE FOR :** BAJAJ AVENGER 150, ELIMINATOR  
**STD. PACK :** 12



**PART NO. :** S115100603  
**APPLICATION :** SHOCK ABSORBER REAR  
**SUITABLE FOR :** BAJAJ BOXER AT  
**STD. PACK :** 12



**PART NO. :** S115100207  
**APPLICATION :** SHOCK ABSORBER FRONT  
**SUITABLE FOR :** BAJAJ M80  
**STD. PACK :** 16



**PART NO. :** S115100307  
**APPLICATION :** SHOCK ABSORBER REAR  
**SUITABLE FOR :** BAJAJ M80  
**STD. PACK :** 12



**PART NO. :** S115100407  
**APPLICATION :** SHOCK ABSORBER REAR  
**SUITABLE FOR :** BAJAJ M80 HD  
**STD. PACK :** 12



**PART NO. :** S115100507  
**APPLICATION :** SHOCK ABSORBER REAR  
**SUITABLE FOR :** BAJAJ M80 RURAL  
**STD. PACK :** 12



**PART NO. :** S20117875M  
**APPLICATION :** SHOCK ABSORBER REAR  
**SUITABLE FOR :** BAJAJ AVENGER CRUISE  
**STD. PACK :** 12



**PART NO. :** S20121601M  
**APPLICATION :** SHOCK ABSORBER REAR  
**SUITABLE FOR :** AVENGER STREET  
**STD. PACK :** 12



**PART NO. :** S135103107  
**APPLICATION :** SHOCK ABSORBER REAR - (BLACK)  
**SUITABLE FOR :** HERO SPLENDOR  
**STD. PACK :** 12



**PART NO. :** S135103207  
**APPLICATION :** SHOCK ABSORBER REAR - (RED)  
**SUITABLE FOR :** HERO SPLENDOR  
**STD. PACK :** 12



**PART NO. :** S135103307  
**APPLICATION :** SHOCK ABSORBER REAR - (CHROME)  
**SUITABLE FOR :** HERO SPLENDOR  
**STD. PACK :** 12



**PART NO. :** S95101801M  
**APPLICATION :** SHOCK ABSORBER REAR - (PLATED)  
**SUITABLE FOR :** HERO SPLENDOR PRO  
**STD. PACK :** 12



**PART NO. :** S95103701M  
**APPLICATION :** SHOCK ABSORBER REAR - BLACK SPRING  
**SUITABLE FOR :** HERO SPLENDOR PRO  
**STD. PACK :** 12



**PART NO. :** S95100601M  
**APPLICATION :** SHOCK ABSORBER REAR  
**SUITABLE FOR :** HERO SPLENDOR PLUS  
**STD. PACK :** 12



**PART NO. :** S95101201M  
**APPLICATION :** SHOCK ABSORBER REAR - (PLATED)  
**SUITABLE FOR :** HERO GLAMOUR, SPLENDOR ISMART  
**STD. PACK :** 12



**PART NO. :** S95100701M  
**APPLICATION :** SHOCK ABSORBER REAR - (RED SPRING)  
**SUITABLE FOR :** HERO PASSION PRO  
**STD. PACK :** 12

# SHOCK ABSORBERS

## MOTORCYCLE SHOCK ABSORBERS



**ENDURANCE**  
Complete Solutions



**PART NO. :** S95103101M  
**APPLICATION :** SHOCK ABSORBER REAR (PLATED SPRING)  
**SUITABLE FOR :** HERO-PASSION  
**STD. PACK :** 12



**PART NO. :** S135104407  
**APPLICATION :** SHOCK ABSORBER REAR  
**SUITABLE FOR :** HERO-PASSION  
**STD. PACK :** 12



**PART NO. :** S115101807  
**APPLICATION :** SHOCK ABSORBER REAR - (BLACK)  
**SUITABLE FOR :** HERO-CD 100  
**STD. PACK :** 12



**PART NO. :** S115101907  
**APPLICATION :** SHOCK ABSORBER REAR (CHROME)  
**SUITABLE FOR :** HERO-CD 100  
**STD. PACK :** 12



**PART NO. :** S115102007  
**APPLICATION :** SHOCK ABSORBER REAR - (RED)  
**SUITABLE FOR :** HERO-CD 100  
**STD. PACK :** 12



**PART NO. :** S135103403  
**APPLICATION :** SHOCK ABSORBER REAR - (BLACK)  
**SUITABLE FOR :** HERO CD 100 SS  
**STD. PACK :** 12



**PART NO. :** S135103603  
**APPLICATION :** SHOCK ABSORBER REAR - (RED)  
**SUITABLE FOR :** HERO CD 100 SS  
**STD. PACK :** 12



**PART NO. :** S135103803  
**APPLICATION :** SHOCK ABSORBER REAR - (CHROME)  
**SUITABLE FOR :** HERO CD 100 SS  
**STD. PACK :** 12



**PART NO. :** S20117701M  
**APPLICATION :** SHOCK ABSORBER REAR - (SILVER SPRING)  
**SUITABLE FOR :** HONDA SHINE UPG  
**STD. PACK :** 12



**PART NO. :** S20115701M  
**APPLICATION :** SHOCK ABSORBER REAR - (RED SPRING)  
**SUITABLE FOR :** HONDA SHINE UPG  
**STD. PACK :** 12



**PART NO. :** S1B0100501  
**APPLICATION :** SHOCK ABSORBER REAR - (BLACK SPRING)  
**SUITABLE FOR :** HONDA SHINE ECO  
**STD. PACK :** 12



**PART NO. :** S115101103  
**APPLICATION :** SHOCK ABSORBER REAR  
**SUITABLE FOR :** YAMAHA RX 100  
**STD. PACK :** 12



**PART NO. :** S201019010  
**APPLICATION :** SHOCK ABSORBER REAR  
**SUITABLE FOR :** YAMAHA SALUTO  
**STD. PACK :** 12



**PART NO. :** S130111701  
**APPLICATION :** SHOCK ABSORBER REAR  
**SUITABLE FOR :** YAMAHA-YBR 110  
**STD. PACK :** 12



**PART NO. :** S130112601  
**APPLICATION :** SHOCK ABSORBER REAR  
**SUITABLE FOR :** YAMAHA-CRUX  
**STD. PACK :** 12



**PART NO. :** S135101207  
**APPLICATION :** SHOCK ABSORBER (HYDRAULIC)  
**SUITABLE FOR :** ROYAL ENFIELD BULLET  
**STD. PACK :** 12

# SHOCK ABSORBERS

## MOTORCYCLE SHOCK ABSORBERS



**ENDURANCE**  
Complete Solutions



**PART NO. :** S20103701M  
**APPLICATION :** SHOCK ABSORBER REAR - HONDA - DREAM YUGA (RED SPRING)  
**SUITABLE FOR :** HONDA DREAM YUGA  
**STD. PACK :** 12



**PART NO. :** S1B0100201  
**APPLICATION :** SHOCK ABSORBER REAR - (SILVER SPRING)  
**SUITABLE FOR :** HONDA - DREAM YUGA  
**STD. PACK :** 12



**PART NO. :** S135104307  
**APPLICATION :** SHOCK ABSORBER  
**SUITABLE FOR :** TVS XL HD  
**STD. PACK :** 12



**PART NO. :** S135106901  
**APPLICATION :** SHOCK ABSORBER  
**SUITABLE FOR :** TVS STAR CITY  
**STD. PACK :** 12



**PART NO. :** S95104701M  
**APPLICATION :** SHOCK ABSORBER  
**SUITABLE FOR :** S/A TVS STAR CITY 110  
**STD. PACK :** 12



**PART NO. :** S135100107  
**APPLICATION :** SHOCK ABSORBER  
**SUITABLE FOR :** TVS VICTOR REAR  
**STD. PACK :** 12



**PART NO. :** S95103301M  
**APPLICATION :** SHOCK ABSORBER REAR  
**SUITABLE FOR :** TVS XL 100  
**STD. PACK :** 12



**PART NO. :** S135101107  
**APPLICATION :** SHOCK ABSORBER  
**SUITABLE FOR :** SUZUKI AX 100  
**STD. PACK :** 12



**PART NO. :** S95102701M  
**APPLICATION :** SHOCK ABSORBER  
**SUITABLE FOR :** HERO HF DLX HEAVY GREY METALLIC  
**STD. PACK :** 12



**PART NO. :** S95104501M  
**APPLICATION :** SHOCK ABSORBER  
**SUITABLE FOR :** HERO PASSION XPRO  
**STD. PACK :** 12



**PART NO. :** S95104601M  
**APPLICATION :** SHOCK ABSORBER  
**SUITABLE FOR :** TVS STAR SPORTS  
**STD. PACK :** 12

# SHOCK ABSORBERS

## MOTORCYCLE SNS SHOCK ABSORBERS



**ENDURANCE**  
Complete Solutions



**PART NO. :** S130100103  
**APPLICATION :** SHOCK ABSORBER REAR - PLATED  
**SUITABLE FOR :** BAJAJ DISCOVER 100/112/125  
**STD. PACK :** 12



**PART NO. :** S130109707  
**APPLICATION :** SHOCK ABSORBER REAR -POWDER COATED  
**SUITABLE FOR :** BAJAJ DISCOVER 100/112/125  
**STD. PACK :** 12



**PART NO. :** S130107303  
**APPLICATION :** SHOCK ABSORBER REAR - PLATED  
**SUITABLE FOR :** BAJAJ-CT 100  
**STD. PACK :** 12



**PART NO. :** S130109607  
**APPLICATION :** SHOCK ABSORBER REAR - POWDER COATED  
**SUITABLE FOR :** BAJAJ-PLATINA  
**STD. PACK :** 12



**PART NO. :** S130113101  
**APPLICATION :** SHOCK ABSORBER REAR  
**SUITABLE FOR :** BAJAJ BOXER 150  
**STD. PACK :** 12



**PART NO. :** S20111301M  
**APPLICATION :** SHOCK ABSORBER REAR (GOLDEN SPRING)  
**SUITABLE FOR :** BAJAJ PLATINA COMFORTEC  
**STD. PACK :** 12



**PART NO. :** S20125501M  
**APPLICATION :** SHOCK ABSORBER  
**SUITABLE FOR :** PLATINA 110  
**STD. PACK :** 12

## MOTORCYCLE GAS & MONO SHOCK ABSORBERS



**PART NO. :** S201001010  
**APPLICATION :** SHOCK ABSORBER REAR - (GAS)  
**SUITABLE FOR :** BAJAJ DISCOVER 125  
**STD. PACK :** 12



**PART NO. :** S330102601  
**APPLICATION :** SHOCK ABSORBER REAR-BLACK (GAS)  
**SUITABLE FOR :** BAJAJ PULSAR 150  
**STD. PACK :** 8



**PART NO. :** S330100303  
**APPLICATION :** SHOCK ABSORBER REAR - (GAS)  
**SUITABLE FOR :** BAJAJ DISCOVER 135  
**STD. PACK :** 8



**PART NO. :** S330101901  
**APPLICATION :** SHOCK ABSORBER REAR-BLACK (GAS)  
**SUITABLE FOR :** BAJAJ PULSAR 135  
**STD. PACK :** 8



**PART NO. :** S330101703  
**APPLICATION :** SHOCK ABSORBER REAR (GAS)  
**SUITABLE FOR :** BAJAJ PULSAR 180  
**STD. PACK :** 8



**PART NO. :** S330102901  
**APPLICATION :** SHOCK ABSORBER REAR-BLACK (GAS)  
**SUITABLE FOR :** BAJAJ PULSAR 220  
**STD. PACK :** 8



**PART NO. :** S20107201M  
**APPLICATION :** SHOCK ABSORBER REAR - (GAS)  
**SUITABLE FOR :** BAJAJ-V 15  
**STD. PACK :** 8



**PART NO. :** S20118401M  
**APPLICATION :** SHOCK ABSORBER GAS BLACK  
**SUITABLE FOR :** BAJAJ DISCOVER 100/125  
**STD. PACK :** 8

# SHOCK ABSORBERS

## MOTORCYCLE GAS & MONO SHOCK ABSORBERS



**ENDURANCE**  
Complete Solutions



**PART NO. :** S20122901M  
**APPLICATION :** SHOCK ABSORBER SOS GAS  
**SUITABLE FOR :** BAJAJ PLATINA 110CC  
**STD. PACK :** 8



**PART NO. :** S95102801M  
**APPLICATION :** SHOCK ABSORBER REAR - (GAS)  
**SUITABLE FOR :** HERO SPLENDOR  
**STD. PACK :** 8



**PART NO. :** S95101101M  
**APPLICATION :** SHOCK ABSORBER REAR - (GAS)  
**SUITABLE FOR :** TVS-APACHE STD. PACK : 8



**PART NO. :** S330100703  
**APPLICATION :** SHOCK ABSORBER REAR - (GAS)  
**SUITABLE FOR :** TVS-VICTOR STD. PACK : 8



**PART NO. :** S330100403  
**APPLICATION :** SHOCK ABSORBER REAR - (GAS)  
**SUITABLE FOR :** ROYAL ENFIELD ELECTRA  
**STD. PACK :** 8



**PART NO. :** S95103401M  
**APPLICATION :** SHOCK ABSORBER REAR - REX UPG (GAS)  
**SUITABLE FOR :** ROYAL ENFIELD -CLASSIC ELECTRA, THUNDERBIRD  
**STD. PACK :** 8



**PART NO. :** S330100803  
**APPLICATION :** SHOCK ABSORBER GAS  
**SUITABLE FOR :** ROYAL ENFIELD BULLET (OLD)  
**STD. PACK :** 8



**PART NO. :** S20116201M  
**APPLICATION :** SHOCK ABSORBER (STEALTH BLACK) GAS  
**SUITABLE FOR :** ROYAL ENFIELD CLASSIC 350  
**STD. PACK :** 8



**PART NO. :** S20105001M  
**APPLICATION :** SHOCK ABSORBER REAR (GAS)  
**SUITABLE FOR :** ROYAL ENFIELD REX  
**STD. PACK :** 8



**PART NO. :** S3C0100201  
**APPLICATION :** SHOCK ABSORBER REAR-(MONO GAS)  
**SUITABLE FOR :** BAJAJ DISCOVER 125 ST  
**STD. PACK :** 2



**PART NO. :** S20103801O  
**APPLICATION :** SHOCK ABSORBER REAR-(MONO GAS)  
**SUITABLE FOR :** BAJAJ DISCOVER 150/150 ST  
**STD. PACK :** 2



**PART NO. :** S3C0100101  
**APPLICATION :** SHOCK ABSORBER REAR-(MONO GAS)  
**SUITABLE FOR :** BAJAJ PULSAR 200 NS  
**STD. PACK :** 2



**PART NO. :** S95106401M  
**APPLICATION :** SHOCK ABSORBER - GAS  
**SUITABLE FOR :** TVS APACHE RTR 160/ RTR 180 GOLDEN  
**STD. PACK :** 8



**PART NO. :** S20119601M  
**APPLICATION :** SHOCK ABSORBER REAR (MONO GAS)  
**SUITABLE FOR :** BAJAJ DOMINAR  
**STD. PACK :** 2

# SHOCK ABSORBERS

## MOTORCYCLE GAS & MONO SHOCK ABSORBERS



**ENDURANCE**  
Complete Solutions



**PART NO. :** S20108301M  
**APPLICATION :** SHOCK ABSORBER (MONO)  
**SUITABLE FOR :** KTM DUKE 250 HD  
**STD. PACK :** 2



**PART NO. :** S20109401M  
**APPLICATION :** SHOCK ABSORBER (MONO)  
**SUITABLE FOR :** KTM DUKE 390 HD  
**STD. PACK :** 2



**PART NO. :** S20113401M  
**APPLICATION :** SHOCK ABSORBER (MONO)  
**SUITABLE FOR :** KTM RC 200 HD 390 HD  
**STD. PACK :** 2



**PART NO. :** S20113101M  
**APPLICATION :** SHOCK ABSORBER (MONO)  
**SUITABLE FOR :** KTM RC 390 HD  
**STD. PACK :** 2



**PART NO. :** S380100401  
**APPLICATION :** SHOCK ABSORBER REAR (MONO)  
**SUITABLE FOR :** KTM DURO  
**STD. PACK :** 4



**PART NO. :** S20112101M  
**APPLICATION :** SHOCK ABSORBER (MONO)  
**SUITABLE FOR :** KTM HUSQVERNA 701  
**STD. PACK :** 4



**PART NO. :** S20109801M  
**APPLICATION :** SHOCK ABSORBER (MONO)  
**SUITABLE FOR :** KTM DUKE 125  
**STD. PACK :** 4



**PART NO. :** S20114601M  
**APPLICATION :** SHOCK ABSORBER (MONO)  
**SUITABLE FOR :** KAWASAKI NINJA  
**STD. PACK :** 4



**PART NO. :** S95101701M  
**APPLICATION :** SHOCK ABSORBER REAR (MONO) (YELLOW SPRING)  
**SUITABLE FOR :** YAMAHA-FZ  
**STD. PACK :** 6



**PART NO. :** S95103201M  
**APPLICATION :** SHOCK ABSORBER REAR (MONO) (RED SPRING)  
**SUITABLE FOR :** YAMAHA-FZ  
**STD. PACK :** 6



**PART NO. :** S20108001M  
**APPLICATION :** SHOCK ABSORBER REAR (MONO)  
**SUITABLE FOR :** SUZUKI GIXXER  
**STD. PACK :** 6



**PART NO. :** S20121801M  
**APPLICATION :** SHOCK ABSORBER (MONO)  
**SUITABLE FOR :** KTM DUKE 200  
**STD. PACK :** 2

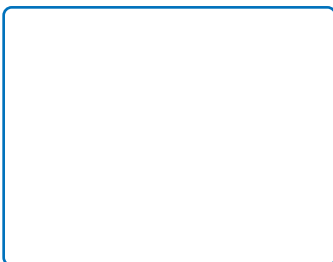

**PART NO. :** S20120401M  
**APPLICATION :** SHOCK ABSORBER REAR (MONO)  
**SUITABLE FOR :** KTM ADVNTURE 390 NHD ADJ  
**STD. PACK :** 2



**PART NO. :** S20127801M  
**APPLICATION :** SHOCK ABSORBER (MONO)  
**SUITABLE FOR :** KTM ADVNTURE 390 HD NON ADJ  
**STD. PACK :** 2



**PART NO. :** S95105501M  
**APPLICATION :** SHOCK ABSORBER (MONO)  
**SUITABLE FOR :** YMH FZ BLACK SPRING  
**STD. PACK :** 6



**PART NO. :** S20119301M  
**APPLICATION :** AIR SUSPENSION  
**SUITABLE FOR :** ATV  
**STD. PACK :** 2

## EXCLUSIVE AFTER MARKET MOTORCYCLE SHOCK ABSORBERS



**ENDURANCE**  
Complete Solutions

### ASEAN MARKET



**PART NO. :** S95101301M  
**APPLICATION :** SHOCK ABSORBER  
**SUITABLE FOR :** HONDA BEAT  
110 CARBURATOR  
**STD. PACK :** 12



**PART NO. :** S95104301M  
**APPLICATION :** SHOCK ABSORBER  
**SUITABLE FOR :** HONDA BEAT FI - 110  
**STD. PACK :** 12



**PART NO. :** S120101812  
**APPLICATION :** SHOCK ABSORBER  
**SUITABLE FOR :** HONDA SUPRA 125  
**STD. PACK :** 12



**PART NO. :** S95104201M  
**APPLICATION :** SHOCK ABSORBER  
**SUITABLE FOR :** HONDA VARIO 125  
**STD. PACK :** 12



**PART NO. :** S90100401M  
**APPLICATION :** SHOCK ABSORBER  
**SUITABLE FOR :** YAMAHA MIO 110  
**STD. PACK :** 12



**PART NO. :** S95106001M  
**APPLICATION :** SHOCK ABSORBER  
**SUITABLE FOR :** YAMAHA MX135 OLD  
**STD. PACK :** 12



**PART NO. :** S95105901M  
**APPLICATION :** REAR SHOCK  
ABSORBER  
**SUITABLE FOR :** YAMAHA JUPITER MX 150  
**STD. PACK :** 12



**PART NO. :** S95105801M  
**APPLICATION :** REAR SHOCK  
ABSORBER  
**SUITABLE FOR :** YAMAHA NMAX 150  
**STD. PACK :** 6

### LATIN AMERICAN MARKET



**PART NO. :** S95104901M  
**APPLICATION :** REAR SHOCK  
ABSORBER  
**SUITABLE FOR :** HONDA BIZ 125  
**STD. PACK :** 12



**PART NO. :** S95104801M  
**APPLICATION :** REAR SHOCK  
ABSORBER  
**SUITABLE FOR :** HONDA CG 150/160 RC  
**STD. PACK :** 12



**PART NO. :** S95105101M  
**APPLICATION :** REAR MONO SHOCK  
ABSORBER  
**SUITABLE FOR :** NXR 150 BROS  
**STD. PACK :** 6



**PART NO. :** S95105001M  
**APPLICATION :** REAR SHOCK  
ABSORBER  
**SUITABLE FOR :** HONDA POP 110  
**STD. PACK :** 12



**PART NO. :** S95103501M  
**APPLICATION :** SHOCK ABSORBER REAR  
**SUITABLE FOR :** TVS HLX 100  
**STD. PACK :** 12



**PART NO. :** S95103601M  
**APPLICATION :** SHOCK ABSORBER REAR  
**SUITABLE FOR :** TVS HLX 125  
**STD. PACK :** 12

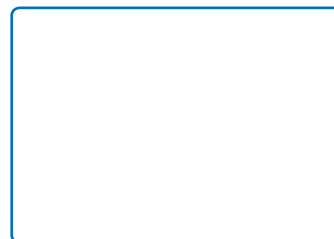

**PART NO. :** S95105201M  
**APPLICATION :** SHOCK ABSORBER REAR  
**SUITABLE FOR :** TVS HLX 150  
**STD. PACK :** 12



# Suspension

Front Forks

## Front Fork Assembly Spares

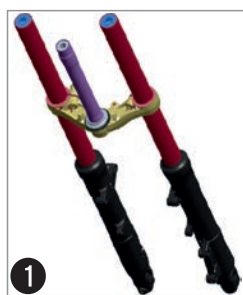

1

FORK ASSEMBLY

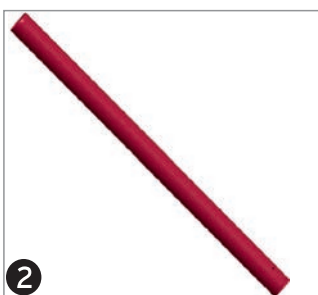

2

FORK PIPE



COLOURED FORK PIPE



3

UNDER BRACKET

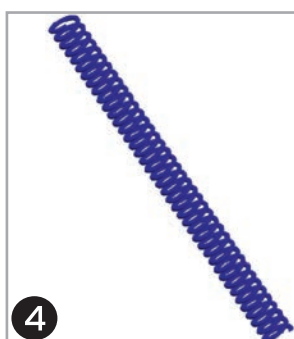

4

MAIN SPRING



5

BOTTOM CASE



6

OIL SEAL



7

STEERING BEARING KIT



8



FORK OIL  
160ML



FORK OIL  
175 ML



FORK OIL  
350ML



FORK OIL 450ML  
(For Inverted Front  
Fork Assy.)

SR. NO.	DESCRIPTION
1	FORK ASSEMBLY
2	FORK PIPE
3	UNDER BRACKET
4	MAIN SPRING
5	BOTTOM CASE
6	OIL SEAL
7	STEERING BEARING KIT
8	FORK OIL

# FRONT FORK ASSEMBLY



**PART NO. :** F800119107  
**APPLICATION :** FRONT FORK ASSY (DRUM WITH GUIDE BUSH)  
**SUITABLE FOR :** BAJAJ DISCOVER 100  
**STD. PACK :** 1



**PART NO. :** F800128407  
**APPLICATION :** FRONT FORK ASSY DRUM WIHTOUT GUIDE BUSH  
**SUITABLE FOR :** BAJAJ-DISCOVER 100 ELECTRIC START  
**STD. PACK :** 1



**PART NO. :** F201005010  
**APPLICATION :** FRONT FORK ASSY  
**SUITABLE FOR :** BAJAJ DISCOVER 100M/125M - DRUM  
**STD. PACK :** 1



**PART NO. :** F201008010  
**APPLICATION :** FRONT FORK ASSY  
**SUITABLE FOR :** BAJAJ DISCOVER 100M/125M- DISC  
**STD. PACK :** 1



**PART NO. :** F800112307  
**APPLICATION :** FRONT FORK ASSY  
**SUITABLE FOR :** BAJAJ DISCOVER 135 DISC  
**STD. PACK :** 1



**PART NO. :** F800100707  
**APPLICATION :** FRONT FORK ASSY BLACK  
**SUITABLE FOR :** BAJAJ DISCOVER 125/135 DRUM  
**STD. PACK :** 1



**PART NO. :** F800108007  
**APPLICATION :** FRONT FORK ASSY  
**SUITABLE FOR :** BAJAJ DISCOVER 125 DISC  
**STD. PACK :** 1



**PART NO. :** F800107907  
**APPLICATION :** FRONT FORK ASSY  
**SUITABLE FOR :** BAJAJ DISCOVER 125 DRUM  
**STD. PACK :** 1



**PART NO. :** F800125207  
**APPLICATION :** FRONT FORK ASSY  
**SUITABLE FOR :** BAJAJ DISCOVER 125 DISC  
**STD. PACK :** 1



**PART NO. :** F20108901M  
**APPLICATION :** FRONT FORK ASSY  
**SUITABLE FOR :** BAJAJ DISCOVER 125 DRUM  
**STD. PACK :** 1



**PART NO. :** F20109001M  
**APPLICATION :** FRONT FORK ASSY SILVER  
**SUITABLE FOR :** BAJAJ DISCOVER 125 DISC  
**STD. PACK :** 1



**PART NO. :** F800126207  
**APPLICATION :** FRONT FORK ASSY  
**SUITABLE FOR :** BAJAJ DISCOVER 150 HF DISC  
**STD. PACK :** 1



**PART NO. :** F20104901M  
**APPLICATION :** FRONT FORK ASSY  
**SUITABLE FOR :** BAJAJ DISCOVER 150 S DISC  
**STD. PACK :** 1



**PART NO. :** F800120107  
**APPLICATION :** FRONT FORK ASSY  
**SUITABLE FOR :** BAJAJ DISCOVER 150 DISC  
**STD. PACK :** 1



**PART NO. :** F20104801M  
**APPLICATION :** FRONT FORK ASSY  
**SUITABLE FOR :** BAJAJ PLATINA 100  
**STD. PACK :** 1



**PART NO. :** F20112001M  
**APPLICATION :** FRONT FORK ASSY  
**SUITABLE FOR :** BAJAJ PLATINA COMFORTEC  
**STD. PACK :** 1

# FRONT FORK ASSEMBLY



**PART NO. :** F800119907  
**APPLICATION :** FRONT FORK ASSY BLACK  
**SUITABLE FOR :** BAJAJ PLATINA 125 - DRUM  
**STD. PACK :** 1



**PART NO. :** F800110407  
**APPLICATION :** FRONT FORK ASSY SILVER  
**SUITABLE FOR :** BAJAJ PLATINA 125 - DRUM  
**STD. PACK :** 1



**PART NO. :** F800117107  
**APPLICATION :** FRONT FORK ASSY (BLACK)  
**SUITABLE FOR :** BAJAJ PLATINA 125 UPG  
**STD. PACK :** 1



**PART NO. :** F800120007  
**APPLICATION :** FRONT FORK ASSY  
**SUITABLE FOR :** BAJAJ PULSAR 150 UG4  
**STD. PACK :** 1



**PART NO. :** F800126307  
**APPLICATION :** FRONT FORK ASSY  
**SUITABLE FOR :** BAJAJ BOXER 150  
**STD. PACK :** 1



**PART NO. :** F800125107  
**APPLICATION :** FRONT FORK ASSY  
**SUITABLE FOR :** BAJAJ BM150  
**STD. PACK :** 1



**PART NO. :** F800111707  
**APPLICATION :** FRONT FORK ASSY  
**SUITABLE FOR :** BAJAJ XCD 125  
**STD. PACK :** 1



**PART NO. :** F800119507  
**APPLICATION :** FRONT FORK ASSY  
**SUITABLE FOR :** BAJAJ PULSAR 180/220 UPG4  
**STD. PACK :** 1



**PART NO. :** F800108907  
**APPLICATION :** FRONT FORK ASSY  
**SUITABLE FOR :** BAJAJ CT DELUXE  
**STD. PACK :** 1



**PART NO. :** F800117607  
**APPLICATION :** FRONT FORK ASSY  
**SUITABLE FOR :** BAJAJ PULSAR 135  
**STD. PACK :** 1



**PART NO. :** F800118507  
**APPLICATION :** FRONT FORK ASSY (BLACK)  
**SUITABLE FOR :** BAJAJ PULSAR 150  
**STD. PACK :** 1



**PART NO. :** F800108307  
**APPLICATION :** FRONT FORK ASSY  
**SUITABLE FOR :** BAJAJ AVANGER (OLD)  
**STD. PACK :** 1



**PART NO. :** F800121707  
**APPLICATION :** FRONT FORK ASSY  
**SUITABLE FOR :** BAJAJ PULSAR 150CC (NEW)  
**STD. PACK :** 1



**PART NO. :** F800128707  
**APPLICATION :** FRONT FORK ASSY  
**SUITABLE FOR :** BAJAJ PULSAR 150AS/ 150NS/ 160 NS  
**STD. PACK :** 1



**PART NO. :** F201030010  
**APPLICATION :** FRONT FORK ASSY  
**SUITABLE FOR :** BAJAJ PULSAR 180  
**STD. PACK :** 1



**PART NO. :** F20107201M  
**APPLICATION :** FRONT FORK ASSY  
**SUITABLE FOR :** BAJAJ VIKRANT  
**STD. PACK :** 1

# FRONT FORK ASSEMBLY



**PART NO. :** F800125507  
**APPLICATION :** FRONT FORK ASSY  
**SUITABLE FOR :** BAJAJ PULSAR 200NS/200AS  
**STD. PACK :** 1



**PART NO. :** F20110701M  
**APPLICATION :** FRONT FORK ASSY  
**SUITABLE FOR :** BAJAJ DOMINAR  
**STD. PACK :** 1



**PART NO. :** F20104701M  
**APPLICATION :** FRONT FORK ASSY  
**SUITABLE FOR :** BAJAJ PULAR 150 NS  
**STD. PACK :** 1



**PART NO. :** F20111301M  
**APPLICATION :** FRONT FORK ASSY  
**SUITABLE FOR :** BAJAJ PULAR 150 NS UPGRADED  
**STD. PACK :** 1



**PART NO. :** F800127107  
**APPLICATION :** FRONT FORK ASSY  
**SUITABLE FOR :** BAJAJ DISCOVER 125 ST  
**STD. PACK :** 1



**PART NO. :** F20112201M  
**APPLICATION :** FRONT FORK ASSY  
**SUITABLE FOR :** BAJAJ PULSAR 200 NS  
**STD. PACK :** 1



**PART NO. :** F800130707  
**APPLICATION :** FRONT FORK ASSY  
**SUITABLE FOR :** KTM DURO 200  
**STD. PACK :** 1



**PART NO. :** F800114607  
**APPLICATION :** FRONT FORK ASSY  
**SUITABLE FOR :** YAMAHA GLADIATOR  
**STD. PACK :** 1



**PART NO. :** F20105301M  
**APPLICATION :** FRONT FORK ASSY  
**SUITABLE FOR :** YAMAHA SALUTO  
**STD. PACK :** 1



**PART NO. :** F800127707  
**APPLICATION :** FRONT FORK ASSY  
**SUITABLE FOR :** YAMAHA CRUX  
**STD. PACK :** 1



**PART NO. :** F20100307M  
**APPLICATION :** FRONT FORK ASSY  
**SUITABLE FOR :** SUZUKI GIXXER  
**STD. PACK :** 1



**PART NO. :** F20100407M  
**APPLICATION :** FRONT FORK ASSY  
**SUITABLE FOR :** MAHINDRA CENTURO  
**STD. PACK :** 1

# FRONT FORK ASSEMBLY

## FORK LEG ASSEMBLY



**ENDURANCE**  
Complete Solutions



**PART NO. :** F800416107  
**APPLICATION :** FORK LEG  
ASSY LH  
**SUITABLE FOR :** ROYAL ENFIELD  
ELECTRA DISC  
**STD. PACK :** 2



**PART NO. :** F800416207  
**APPLICATION :** FORK LEG  
ASSY RH  
**SUITABLE FOR :** ROYAL ENFIELD  
ELECTRA DISC  
**STD. PACK :** 2



**PART NO. :** F800419107  
**APPLICATION :** FORK LEG  
ASSY LH  
**SUITABLE FOR :** ROYAL ENFIELD  
BULLET 350 (RE STD)  
**STD. PACK :** 2



**PART NO. :** F800419207  
**APPLICATION :** FORK LEG  
ASSY RH  
**SUITABLE FOR :** ROYAL ENFIELD  
BULLET 350 (RE STD)  
**STD. PACK :** 1



**PART NO. :** F800420507  
**APPLICATION :** FORK LEG  
ASSY LH  
**SUITABLE FOR :** ROYAL ENFIELD  
CLSSC 500 (C5)  
**STD. PACK :** 2



**PART NO. :** F800420607  
**APPLICATION :** FORK LEG  
ASSY RH  
**SUITABLE FOR :** ROYAL ENFIELD  
CLSSC 500 (C5)  
**STD. PACK :** 2



**PART NO. :** F800424007  
**APPLICATION :** FORK LEG  
ASSY LH  
**SUITABLE FOR :** ROYAL ENFIELD  
MACHISMO  
**STD. PACK :** 2



**PART NO. :** F800424107  
**APPLICATION :** FORK LEG  
ASSY RH  
**SUITABLE FOR :** ROYAL ENFIELD  
MACHISMO  
**STD. PACK :** 2



**PART NO. :** F800431107  
**APPLICATION :** FORK LEG  
ASSY LH  
**SUITABLE FOR :** ROYAL ENFIELD  
CLASSIC 500 NEW  
**STD. PACK :** 2



**PART NO. :** F800431207  
**APPLICATION :** FORK LEG  
ASSY RH  
**SUITABLE FOR :** ROYAL ENFIELD  
CLASSIC 500 NEW  
**STD. PACK :** 2



**PART NO. :** F800438207  
**APPLICATION :** FORK LEG  
ASSY LH  
**SUITABLE FOR :** ROYAL ENFIELD  
CLASSIC 350 (NEW)  
**STD. PACK :** 2



**PART NO. :** F800438307  
**APPLICATION :** FORK LEG  
ASSY RH  
**SUITABLE FOR :** ROYAL ENFIELD  
CLASSIC 350 (NEW)  
**STD. PACK :** 2



**PART NO. :** F20407101M  
**APPLICATION :** FORK LEG  
ASSY (LH)  
**SUITABLE FOR :** HERO  
SPLENDOR PRO  
**STD. PACK :** 2



**PART NO. :** F20407201M  
**APPLICATION :** FORK LEG  
ASSY (RH)  
**SUITABLE FOR :** HERO  
SPLENDOR PRO  
**STD. PACK :** 2



**PART NO. :** F800438807  
**APPLICATION :** FORK LEG  
ASSY LH  
**SUITABLE FOR :** HERO PASSION  
PRO  
**STD. PACK :** 2



**PART NO. :** F800438907  
**APPLICATION :** FORK LEG  
ASSY RH  
**SUITABLE FOR :** HERO PASSION  
PRO  
**STD. PACK :** 2

# FRONT FORK ASSEMBLY

## FORK LEG ASSEMBLY



**ENDURANCE**  
Complete Solutions



**PART NO. :** F800433107  
**APPLICATION :** FORK LEG ASSY LH  
**SUITABLE FOR :** HONDA DREAM - YUGA  
**STD. PACK :** 2



**PART NO. :** F800433207  
**APPLICATION :** FORK LEG ASSY RH  
**SUITABLE FOR :** HONDA DREAM - YUGA  
**STD. PACK :** 2



**PART NO. :** F20410901M  
**APPLICATION :** FORK LEG ASSY LH  
**SUITABLE FOR :** HONDA LIVO  
**STD. PACK :** 2



**PART NO. :** F20411001M  
**APPLICATION :** FORK LEG ASSY RH  
**SUITABLE FOR :** HONDA LIVO  
**STD. PACK :** 2



**PART NO. :** F20408301M  
**APPLICATION :** FORK LEG ASSY LH  
**SUITABLE FOR :** HONDA SHINE DRUM  
**STD. PACK :** 2



**PART NO. :** F20408401M  
**APPLICATION :** FORK LEG ASSY RH  
**SUITABLE FOR :** HONDA SHINE DRUM  
**STD. PACK :** 2



**PART NO. :** F20407501M  
**APPLICATION :** FORK LEG ASSY LH  
**SUITABLE FOR :** HONDA SHINE CBS  
**STD. PACK :** 2



**PART NO. :** F20407601M  
**APPLICATION :** FORK LEG ASSY RH  
**SUITABLE FOR :** HONDA SHINE CBS  
**STD. PACK :** 2



**PART NO. :** F20408501M  
**APPLICATION :** FORK LEG ASSY DISC LH  
**SUITABLE FOR :** HONDA SHINE  
**STD. PACK :** 2



**PART NO. :** F20408601M  
**APPLICATION :** FORK LEG ASSY DISC RH  
**SUITABLE FOR :** HONDA SHINE  
**STD. PACK :** 2



**PART NO. :** F20401275M  
**APPLICATION :** FORK LEG ASSY LH  
**SUITABLE FOR :** SUZUKI GIXXER  
**STD. PACK :** 2



**PART NO. :** F20401175M  
**APPLICATION :** FORK LEG ASSY RH  
**SUITABLE FOR :** SUZUKI GIXXER  
**STD. PACK :** 2



**PART NO. :** F20404901O  
**APPLICATION :** FORK LEG ASSY LH DRUM  
**SUITABLE FOR :** YAMAHA SALUTO  
**STD. PACK :** 2



**PART NO. :** F20405001O  
**APPLICATION :** FORK LEG ASSY RH DRUM  
**SUITABLE FOR :** YAMAHA SALUTO  
**STD. PACK :** 2



**PART NO. :** F20452401M  
**APPLICATION :** FORK LEG ASSY LH  
**SUITABLE FOR :** TVS XL 100  
**STD. PACK :** 2



**PART NO. :** F20452501M  
**APPLICATION :** FORK LEG ASSY RH  
**SUITABLE FOR :** TVS XL 100  
**STD. PACK :** 2

# FRONT FORK ASSEMBLY

## FORK PIPE

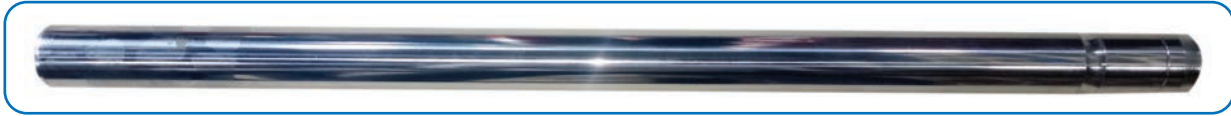

ETL PART NO.	DESCRIPTION	APPLICABLE	STD. PACK
F800200404	FORK PIPE	BAJAJ-4S CHAMPION, BOXER 100/AT/CT	6
F800210604	FORK PIPE	BAJAJ-BOXER 150	6
F800204104	FORK PIPE	BAJAJ CT 100, PLATINA	6
F800200504	FORK PIPE	BAJAJ CALIBER / CROMA	6
F800200604	FORK PIPE	BAJAJ PULSAR 150, CALIBER, CROMA	6
F800202304	FORK PIPE	BAJAJ PULSAR 150/180 UPG	6
F800200104	FORK PIPE	BAJAJ PULSAR 150/180 UPG (ALLOY WHEEL)	6
F800207504	FORK PIPE	BAJAJ PULSAR 135	6
F800209604	FORK PIPE	BAJAJ PULSAR 150 UPG4	6
F800209004	FORK PIPE	BAJAJ PULSAR 180 UPG4	6
F800205404	FORK PIPE	BAJAJ PULSAR 200	6
F800210804	FORK PIPE	BAJAJ PULSAR 150 NS/200 NS	6
F800203104	FORK PIPE	BAJAJ PULSAR 200/220	6
F800200304	FORK PIPE	BAJAJ DISCOVER 112	6
F800200204	FORK PIPE	BAJAJ DISCOVER 125/135 (OLD)	6
F800213804	FORK PIPE	BAJAJ DISCOVER 125 ST (DRUM)	6
F20200304O	FORK PIPE	BAJAJ DISCOVER 150	6
F20203204M	FORK PIPE	BAJAJ DISCOVER 125 (NEW)	6
F20205005M	FORK PIPE	BAJAJ PLATINA COMFORTEC	6
F800214704	FORK PIPE	BAJAJ PULSAR 200 RS	6
F800203704	FORK PIPE	BAJAJ AVENGER 150/220	6
F20200304M	FORK PIPE	BAJAJ SUPER PLATINA	6
F800204304	FORK PIPE	BAJAJ DISCOVER 100, XCD 125/135	6
F800200904	FORK PIPE	BAJAJ ELIMINATOR	6
F800207604	FORK PIPE	HERO SPLENDOR	6
F800207704	FORK PIPE	HERO CD DAWN/DELUXE, PASSION, SPLENDOR PLUS	6
F800208304	FORK PIPE	HERO CD 100 SS	6
F800212704	FORK PIPE	HERO GLAMOUR, SPLENDOR, SPLENDOR PRO	6
F90200402M	FORK PIPE	HONDA UNICORN	6
F20201805M	FORK PIPE	HONDASHINE	6
F800211704	FORK PIPE	HONDA DREAM YUGA	6
F90200202M	FORK PIPE	TVS APACHE	6
F800207804	FORK PIPE	TVS STAR CITY	6
F800207904	FORK PIPE	TVS VICTOR	6
F800205804	FORK PIPE	YAMAHA GLADIATOR	6
F800211404	FORK PIPE	YAMAHA SALUTO	6
F800211804	FORK PIPE	YAMAHA CRUX	6
F90200102M	FORK PIPE	YAMAHA FZ	6
F800203604	FORK PIPE	ROYAL ENFIELD ELECTRA	6
F800213604	FORK PIPE	ROYAL ENFIELD CLASSIC 350CC	6
F800211004	FORK PIPE	ROYAL ENFIELD CLASSIC 500CC	6
F2FA00404M	FORK PIPE	SUZUKI GIXXER	6
F90200302M	FORK PIPE	SUZUKI ACCESS	6
F20200504M	FORK PIPE	MAHINDRA CENTURO	6

# FRONT FORK ASSEMBLY



## PVD COATED FORK PIPE (COLOURED)



ETL PART NO.	DESCRIPTION	APPLICABLE	STD. PACK
F90201002M	FORK PIPE (GOLDEN)	BAJAJ-PULSAR UPG4	6
F90201202M	FORK PIPE (GOLDEN)	HERO SPLENDOR PLUS/DAWN/DELUXE /PASSION	6
F90201102M	FORK PIPE (BLACK)	BAJAJ PULSAR UPG4	6
F90201302M	FORK PIPE (BLACK)	HERO-SPLENDOR PLUS/DAWN/DELUXE /PASSION	6

## MAIN SPRING

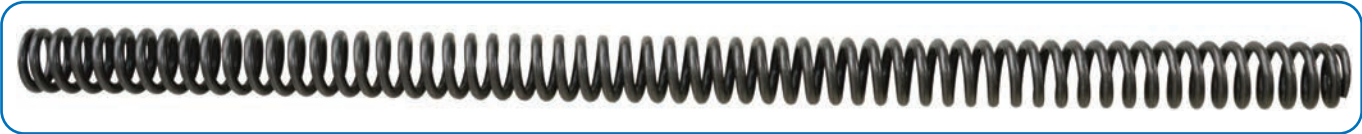

ETL PART NO.	DESCRIPTION	APPLICABLE	STD. PACK
520GN00375	MAIN SPRING	BAJAJ DISCOVER 112	12
520GN00175	MAIN SPRING	BAJAJ BOXER 150, DISCOVER 125/135	12
520GN00275	MAIN SPRING	BAJAJ PULSAR 150/180 UG2	12
520GN00575	MAIN SPRING	BAJAJ 4S CHAMPION, BOXER 100/AT/CT	12
520GN00675	MAIN SPRING	BAJAJ CALIBER, CALIBER 115, CROMA	12
520GN00875	MAIN SPRING	BAJAJ CT 100, PLATINA	12
550GN05375	MAIN SPRING	BAJAJ PULSAR 180 UG4	12
520GN08175	MAIN SPRING	BAJAJ PULSAR 220	12
F2GN07375M	MAIN SPRING	BAJAJ PLATINA COMFORTEC	12
520GN00975	MAIN SPRING	BAJAJ AVENGER 220	12
550GN07475	MAIN SPRING	BAJAJ PULSAR 150 NS/200 NS	12
550GN07675	MAIN SPRING	BAJAJ DISCOVER 125 ST/150	12
550GN08875	MAIN SPRING	BAJAJ PULSAR 150 AS	12
F2GN03102B	MAIN SPRING	BAJAJ PULSAR 200 RS	12
520GN08975	MAIN SPRING	BAJAJ PULSAR 200	12
550GN09175	MAIN SPRING	HERO SPLENDOR PLUS	12
550GN08575	MAIN SPRING	HONDA DREAM YUGA	12
520GN03675	MAIN SPRING	ROYAL ENFIELD ELECTRA	12
550GN00575	MAIN SPRING	YAMAHA GLADIATOR	12
F2GN00902B	MAIN SPRING	MAHINDRA CENTURO	12



# FRONT FORK ASSEMBLY



**ENDURANCE**  
Complete Solutions

## FORK OIL SEAL



**PART NO. :** 520HN00375  
**APPLICATION :** FORK OIL SEAL  
**SUITABLE FOR :** BAJAJ-4S  
CHAMPION, BOXER 100/AT/CT,  
CT 100, XCD 125, HERO SPLENDOR,  
SPLENDOR PLUS / PRO  
**STD. PACK :** 250



**PART NO. :** 520HN00275  
**APPLICATION :** FORK OIL SEAL  
**SUITABLE FOR :** BAJAJ-BOXER  
150, CALIBER, CROMA,  
DISCOVER 135,  
PULSAR 150/150 AS/180  
**STD. PACK :** 250



**PART NO. :** 520HN03575  
**APPLICATION :** FORK OIL SEAL  
**SUITABLE FOR :** BAJAJ-AVENGER  
150/220, DISCOVER 125 ST,  
PULSAR 200  
**STD. PACK :** 50



**PART NO. :** 520HN03775  
**APPLICATION :** FORK OIL SEAL  
**SUITABLE FOR :** BAJAJ  
PULSAR 220  
**STD. PACK :** 50



**PART NO. :** 550HN00975  
**APPLICATION :** FORK OIL SEAL  
BLUE COLOUR  
**SUITABLE FOR :** BAJAJ-  
BOXER 100/AT/CT,  
HERO - SPLENDOR/ PLUS / PRO  
**STD. PACK :** 250



**PART NO. :** 550HN01075  
**APPLICATION :** OIL SEAL  
**SUITABLE FOR :** BAJAJ  
DOMINAR  
**STD. PACK :** 50



**PART NO. :** 520HN03075  
**APPLICATION :** FORK OIL SEAL  
**SUITABLE FOR :** ROYAL ENFIELD  
ELECTRA  
**STD. PACK :** 50



**PART NO. :** 550HN00575  
**APPLICATION :** FORK OIL SEAL  
**SUITABLE FOR :** ROYAL ENFIELD  
BULLET 350 (OLD), CLASSIC  
**STD. PACK :** 50



**PART NO. :** 550HN01675  
**APPLICATION :** FORK OIL SEAL  
**SUITABLE FOR :** SUZUKI  
GIXXER  
**STD. PACK :** 50

# FRONT FORK ASSEMBLY

## BOTTOM CASE - DRUM



ETL PART NO.	APPLICATION	SUITABLE FOR	STD. PACK
080BF00607	BOTTOM CASE - RH	BAJAJ-BOXER 100/AT/CT, CT 100	6
080BF00707	BOTTOM CASE - LH	BAJAJ-BOXER 100 / AT / CT, CT -100	6
550BF17607	BOTTOM CASE - LH	BAJAJ-BOXER 150	6
550BF17707	BOTTOM CASE - RH	BAJAJ-BOXER 150	6
550BF11107	BOTTOM CASE - LH WITH GUIDE BUSH	BAJAJ-DISCOVER 100	6
550BF11207	BOTTOM CASE - RH WITH GUIDE BUSH	BAJAJ-DISCOVER 100	6
550BF24507	BOTTOM CASE - LH WITHOUT GUIDE BUSH	BAJAJ-DISCOVER 100	6
550BF24607	BOTTOM CASE - RH WITHOUT GUIDE BUSH	BAJAJ-DISCOVER 100	6
550BF19807	BOTTOM CASE - LH	BAJAJ-DISCOVER 100T/125T	6
550BF19907	BOTTOM CASE - RH	BAJAJ-DISCOVER 100T/125T	6
080BF00307	BOTTOM CASE - LH	BAJAJ-DISCOVER 125	6
080BF00407	BOTTOM CASE - RH	BAJAJ-DISCOVER 125	6
080BF10007	BOTTOM CASE - LH	BAJAJ-DISCOVER 125	6
080BF10107	BOTTOM CASE - RH	BAJAJ-DISCOVER 125	6
550BF05407	BOTTOM CASE - LH	BAJAJ-XCD 135	6
550BF05507	BOTTOM CASE - RH	BAJAJ-XCD 135	6
080BF13607	BOTTOM CASE - RH	BAJAJ-XCD 125	6
080BF13507	BOTTOM CASE - LH	BAJAJ-XCD 125	6
550BF13507	BOTTOM CASE - LH BLACK	BAJAJ-PLATINA	6
550BF13607	BOTTOM CASE - RH BLACK	BAJAJ-PLATINA	6
550BF19207	BOTTOM CASE - LH	BAJAJ-DISCOVER 125 ST/150 ST	6
550BF19307	BOTTOM CASE - RH	BAJAJ-DISCOVER 125 ST/150 ST	6
F2BF07407M	BOTTOM CASE - LH	BAJAJ-PLATINA NEW	6
F2BF07507M	BOTTOM CASE -RH	BAJAJ-PLATINA NEW	6
F2BF05607M	BOTTOM CASE - LH	HERO-SPLENDOR PRO	6
F2BF05707M	BOTTOM CASE - RH	HERO-SPLENDOR PRO	6
550BF25307	BOTTOM CASE - LH	HONDA-DREAM YUGA	6
550BF25407	BOTTOM CASE - RH	HONDA-DREAM YUGA	6
F2BF00907M	BOTTOM CASE - LH	MAHINDRA-CENTURO	6
F2BF01007M	BOTTOM CASE - RH	MAHINDRA-CENTURO	6
550BF00307	BOTTOM CASE - LH	YAMAHA-GLADIATOR	6
550BF00407	BOTTOM CASE - RH	YAMAHA-GLADIATOR	6
F2BF07607M	BOTTOM CASE - LH	HONDA-LIVO	6
F2BF07707M	BOTTOM CASE - RH	HONDA-LIVO	6
F2BF04707M	BOTTOM CASE - LH	HONDA-SHINE	6
F2BF04807M	BOTTOM CASE - RH	HONDA-SHINE	6
550BF25107	BOTTOM CASE - LH	HERO-PASSION PRO	6
550BF25207	BOTTOM CASE - RH	HERO-PASSION PRO	6

# FRONT FORK ASSEMBLY

## BOTTOM CASE - DISC



ETL PART NO.	APPLICATION	SUITABLE FOR	STD. PACK
550BF11907	BOTTOM CASE - LH	BAJAJ-DISCOVER 125	6
550BF12007	BOTTOM CASE - RH	BAJAJ-DISCOVER 125	6
550BF20007	BOTTOM CASE - LH	BAJAJ-DISCOVER 125ST/100T/125T	6
550BF20107	BOTTOM CASE - RH	BAJAJ-DISCOVER 125ST/100T/125T	6
080BF00107	BOTTOM CASE - LH	BAJAJ-PULSAR 150 (ALLOY WHEEL) UPG	6
080BF00207	BOTTOM CASE - RH	BAJAJ-PULSAR 150 (ALLOY WHEEL) UPG	6
080BF01307	BOTTOM CASE - LH	BAJAJ-AVENGER 150/220/ ELEMİNATOR	6
080BF02907	BOTTOM CASE - RH	BAJAJ-AVENGER 150/220/ ELEMİNATOR	6
080BF06607	BOTTOM CASE - LH	BAJAJ-PULSAR 220	6
080BF06707	BOTTOM CASE - RH	BAJAJ-PULSAR 220	6
550BF06607	BOTTOM CASE - LH	BAJAJ-PULSAR 135	6
550BF06707	BOTTOM CASE - RH	BAJAJ-PULSAR 135	6
550BF09507	BOTTOM CASE - LH	BAJAJ-PULSAR 180 UPG4	6
550BF09607	BOTTOM CASE - RH	BAJAJ-PULSAR 180 UPG4	6
550BF09707	BOTTOM CASE - (BLACK) LH	BAJAJ-PULSAR 150 UPG	6
550BF09807	BOTTOM CASE - (BLACK) RH	BAJAJ-PULSAR 150 UPG	6
550BF17407	BOTTOM CASE -LH	BAJAJ-PULSAR 150 NS / 200 NS	6
550BF17507	BOTTOM CASE - RH	BAJAJ-PULSAR 150 NS / 200 NS	6
F2BF00307O	BOTTOM CASE - LH	BAJAJ-DISCOVER 150	6
F2BF00407O	BOTTOM CASE - RH	BAJAJ-DISCOVER 150	6
F2BF00707O	BOTTOM CASE - LH	BAJAJ-DISCOVER 150	6
F2BF00807O	BOTTOM CASE - RH	BAJAJ-DISCOVER 150	6
F2BF07007M	BOTTOM CASE - LH	HONDA-LIVO	6
F2BF07107M	BOTTOM CASE - RH	HONDA-LIVO	6
F2BF05007M	BOTTOM CASE - LH	HONDA-SHINE	6
F2BF05107M	BOTTOM CASE - RH	HONDA-SHINE	6
F2BF05007M	BOTTOM CASE - LH	HONDA-SHINE	6
F2BF04507M	BOTTOM CASE - RH	HONDA-SHINE	6

# FRONT FORK ASSEMBLY

## UNDER BRACKET



ETL PART NO.	APPLICATION	SUITABLE FOR	STD. PACK
520PC00275	UNDER BRACKET	BAJAJ-DISCOVER 125/135	8
520PC00375	UNDER BRACKET	BAJAJ-DISCOVER 112	8
520PC00975	UNDER BRACKET	BAJAJ-BOXER 100/AT/CT, CALIBER 115	6
520PC01075	UNDER BRACKET	BAJAJ-CALIBER / CROMA	8
520PC01675	UNDER BRACKET	BAJAJ-CT 100, PLATINA	8
520PC03375	UNDER BRACKET	BAJAJ-PULSAR 220	3
550PC09875	UNDER BRACKET	BAJAJ-PULSAR 135	8
F800500575	UNDER BRACKET	BAJAJ-PULSAR 150 DTSI	8
F205006070	UNDER BRACKET	BAJAJ-DISCOVER 150 HF	8
F20500807B	UNDER BRACKET	BAJAJ-DISCOVER 150 HF	8
F20502107B	UNDER BRACKET	BAJAJ-PLATINA NEW	8
F800500106	UNDER BRACKET	BAJAJ-AVENGER 150/220	8
F800502607	UNDER BRACKET	BAJAJ-BOXER 150	8
F800509607	UNDER BRACKET	BAJAJ-PULSAR 150 AS	8
F800509907	UNDER BRACKET	BAJAJ-PULSAR 200 RS	8
F800507807	UNDER BRACKET	BAJAJ-PULSAR 150 NS/200 NS	3
F800510107	UNDER BRACKET	BAJAJ-DISCOVER 125 ST	8
F800501307	UNDER BRACKET	YAMAHA-GLADIATOR	8
F20501807B	UNDER BRACKET	MAHINDRA-CENTURO	8

## FORK OIL



**PART NO. :** 520PV00875  
**APPLICATION :** FORK OIL  
160 ML  
**STD. PACK :** 40



**PART NO. :** 520PV00675  
**APPLICATION :** FORK OIL  
175 ML  
**STD. PACK :** 40



**PART NO. :** 520PV00275  
**APPLICATION :** FORK OIL  
350 ML  
**STD. PACK :** 20



FORK OIL KTM - 450 ML

# FRONT FORK ASSEMBLY

## STEERING BEARING KIT - 2WHEELER



ETL PART NO.	APPLICATION	SUITABLE FOR	STD. PACK
F800601607	STEERING BEARING KIT	BAJAJ-4S CHAMPION, BOXER 100	64
F800603307	STEERING BEARING KIT	BAJAJ-PULSAR 220	64
F800601907	STEERING BEARING KIT	BAJAJ-M80	24
F800602107	STEERING BEARING KIT	BAJAJ-CHETAK NEW MODEL	24
F800601407	STEERING BEARING KIT	HERO-AMBITION, PASSION, SPLENDOR	64
F800601507	STEERING BEARING KIT	HERO-KARIZMA, SPLENDOR, HONDA - SHINE, UNICORN	64
F800603207	STEERING BEARING KIT	HONDA-ACTIVA 100, ETERNO	56
F800600807	STEERING BEARING KIT	ROYAL ENFIELD-BULLET 350 (OLD)	32
F800600907	STEERING BEARING KIT	ROYAL ENFIELD-BULLET ELECTRA	32
F800601307	STEERING BEARING KIT	SUZUKI-AX 100, SAMURAI	64
F800601707	STEERING BEARING KIT	TVS-VICTOR GLX	27
F800601807	STEERING BEARING KIT	TVS-CENTRA	27
F800603107	STEERING BEARING KIT	TVS-STAR CITY	64
F800601207	STEERING BEARING KIT	YAMAHA-CRUX, LIBERO, RX 100	64
F800602207	STEERING BEARING KIT	LML-VESPA	24

## STEERING BEARING KIT - 3WHEELER



ETL PART NO.	APPLICATION	SUITABLE FOR	STD. PACK
F800602307	STEERING BEARING KIT	BAJAJ-3W 2 STROKE (5 PORT) OLD MODEL	24
F800602407	STEERING BEARING KIT	BAJAJ-3W 2 STROKE (5 PORT) NEW MODEL	24
F800602507	STEERING BEARING KIT	BAJAJ-3W 4 STROKE CNG	24
F800602607	STEERING BEARING KIT	BAJAJ-GC 1000	27
F800602807	STEERING BEARING KIT	MAHINDRA-ALFA, PIAGGIO - APE	27
F800603507	STEERING BEARING KIT	MAHINDRA-ALFA, PIAGGIO - APE	64

# FRONT FORK ASSEMBLY

## 2W STEERING BEARING KIT WITH BALL CAGE



ETL PART NO.	APPLICATION	SUITABLE FOR	STD. PACK
520AM01498	STEERING BEARING KIT - BALL CAGE	HERO SPLENDOR	20
520AM01499	STEERING BEARING KIT - BALL CAGE	HERO SUPER SPLENDOR	20
520AM01504	STEERING BEARING KIT - BALL CAGE	HONDA ACTIVA/ETERNO	20
520AM01500	STEERING BEARING KIT - BALL CAGE	BAJAJ KB-4S/PULSAR	20
520AM01509	STEERING BEARING KIT - BALL CAGE	BAJAJ DISCOVER 100ST	20
520AM01503	STEERING BEARING KIT - BALL CAGE	TVS STAR CITY	20
520AM01510	STEERING BEARING KIT - BALL CAGE	TVS JUPITOR	20
520AM01511	STEERING BEARING KIT - BALL CAGE	SUZUKI ACCESS OLD	20

## 3W STEERING BEARING KIT WITH BALL CAGE



**PART NO. :** 520AM01501  
**APPLICATION :** STEERING BEARING KIT - BALL CAGE  
**SUITABLE FOR :** PIAGGIO APE/ MAHINDRA ALFA (DUST CAP)  
**STD. PACK :** 27



**PART NO. :** 520AM01505  
**APPLICATION :** STEERING BEARING UPPER SET - BALL CAGE  
**SUITABLE FOR :** PIAGGIO APE/ MAHINDRA ALFA  
**STD. PACK :** 64



**PART NO. :** 520AM01506  
**APPLICATION :** STEERING BEARING LOWER SET - BALL CAGE  
**SUITABLE FOR :** PIAGGIO APE/ MAHINDRA ALFA  
**STD. PACK :** 27



**PART NO. :** 520AM01507  
**APPLICATION :** STEERING BEARING - BALL CAGE SET  
**SUITABLE FOR :** PIAGGIO APE/ MAHINDRA ALFA  
**STD. PACK :** 50



**PART NO. :** F800603407  
**APPLICATION :** STEERING BEARING KIT  
**SUITABLE FOR :** BAJAJ-3W 175 / RE 205 CNG  
**STD. PACK :** 24



**PART NO. :** 520AM00242  
**APPLICATION :** STEERING BEARING KIT  
**SUITABLE FOR :** BAJAJ-3W COMPACT  
**STD. PACK :** 24

# Transmission

Products



1



2



3



4



5



6

SR. NO.	DESCRIPTION
1	FRICITION CLUTCH
2	CVT ASSEMBLY
3	CLUTCH ASSEMBLY
4	HUB CLUTCH
5	WHEEL CLUTCH
6	HOUSING CLUTCH

# CLUTCH - 3WHEELER

## BAJAJ AUTO - 3WHEELER 2STROKE (RR)



**ENDURANCE**  
Complete Solutions



**PART NO. :** 1640100101  
**APPLICATION :** CLUTCH ASSY  
**SUITABLE FOR :** BAJAJ 3WH 2ST RR  
**STD. PACK :** 4



**PART NO. :** 520CE00875  
**APPLICATION :** CLUTCH BUSH ASSY  
**SUITABLE FOR :** BAJAJ 3WH 2ST RR  
**STD. PACK :** 10



**PART NO. :** 520CL00275  
**APPLICATION :** CUP FOR SPRING  
**SUITABLE FOR :** BAJAJ 3WH 2ST RR  
**STD. PACK :** 350



**PART NO. :** 520FG01275  
**APPLICATION :** ENGINE GEAR  
**SUITABLE FOR :** BAJAJ 3WH 2ST RR  
**STD. PACK :** 10



**PART NO. :** 164FC00129  
**APPLICATION :** FRICTION CLUTCH  
**SUITABLE FOR :** BAJAJ 3WH 2ST RR  
**STD. PACK :** 180

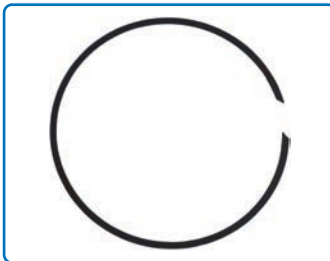

**PART NO. :** 520KQ00275  
**APPLICATION :** LOCK RING  
**SUITABLE FOR :** BAJAJ 3WH 2ST RR  
**STD. PACK :** 105



**PART NO. :** 160JT00801  
**APPLICATION :** DRIVEN & OUTER PLATE SET (SET OF 3)  
**SUITABLE FOR :** BAJAJ 3WH 2ST  
**STD. PACK :** 30

## BAJAJ AUTO - 3WHEELER 2STROKE DI (RR)



**PART NO. :** 1640100301  
**APPLICATION :** CLUTCH ASSY  
**SUITABLE FOR :** BAJAJ 3WH 2ST (DI) (CNG)  
**STD. PACK :** 4



**PART NO. :** 1640101001  
**APPLICATION :** CLUTCH ASSY  
**SUITABLE FOR :** BAJAJ 3WH 2ST (DI) (LPG)  
**STD. PACK :** 4



**PART NO. :** 164FC00329  
**APPLICATION :** FRICTION CLUTCH  
**SUITABLE FOR :** BAJAJ 3WH 2ST (DI)  
**STD. PACK :** 208



**PART NO. :** 160JT01101  
**APPLICATION :** PLATE CLUTCH & OUTER PLATE SET (SET OF 4)  
**SUITABLE FOR :** BAJAJ 3WH 2ST (DI)  
**STD. PACK :** 30



**PART NO. :** 520CL00375  
**APPLICATION :** SPRING CUP SET OF 7  
**SUITABLE FOR :** BAJAJ 3WH 2ST (DI) COMPACT  
**STD. PACK :** 350



**PART NO. :** 520FG02075  
**APPLICATION :** ENGINE GEAR  
**SUITABLE FOR :** BAJAJ 3WH 2ST (DI) COMPACT  
**STD. PACK :** 10



**PART NO. :** 520MD04075  
**APPLICATION :** SPRING CLUTCH SET OF 7  
**SUITABLE FOR :** BAJAJ 3WH 2ST (DI) COMPACT  
**STD. PACK :** 350



**PART NO. :** 520CE00575  
**APPLICATION :** CLUTCH SHAFT  
**SUITABLE FOR :** BAJAJ 3WH 2ST (DI) COMPACT  
**STD. PACK :** 10



# CLUTCH - 3WHEELER



**ENDURANCE**  
Complete Solutions

## BAJAJ AUTO 3WHEELER 2ST RR AUTO START (PETROL/LPG/CNG)

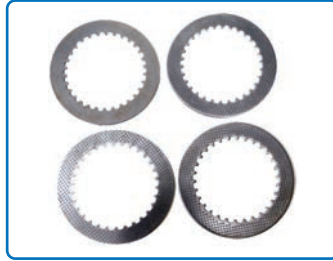

**PART NO. :** 160JT00401  
**APPLICATION :** PLATE CLUTCH SET  
**SUITABLE FOR :** BAJAJ 2ST RR LPG/CNG  
**STD. PACK :** 30



**PART NO. :** 163FC00129  
**APPLICATION :** FRICTION CLUTCH  
**SUITABLE FOR :** BAJAJ 2ST RR LPG / PETROL  
**STD. PACK :** 240

## BAJAJ AUTO 3WHEELER 4ST CARGO



**PART NO. :** 1690101401  
**APPLICATION :** CLUTCH ASSY  
**SUITABLE FOR :** BAJAJ 4ST CARGO  
**STD. PACK :** 4



**PART NO. :** 1690200939  
**APPLICATION :** HOUSING CLUTCH  
**SUITABLE FOR :** BAJAJ 4ST CARGO  
**STD. PACK :** 4



**PART NO. :** 520JT04975  
**APPLICATION :** PLATE CLUTCH  
**SUITABLE FOR :** BAJAJ 4ST CARGO  
**STD. PACK :** 60



**PART NO. :** 520PP00175  
**APPLICATION :** WHEEL CLUTCH  
**SUITABLE FOR :** BAJAJ 4ST CARGO  
**STD. PACK :** 30



**PART NO. :** 160FC00201  
**APPLICATION :** FRICTION CLUTCH SET  
**SUITABLE FOR :** BAJAJ 4ST CARGO  
**STD. PACK :** 45



**PART NO. :** 169FZ00522  
**APPLICATION :** HUB CLUTCH  
**SUITABLE FOR :** BAJAJ 4ST CARGO  
**STD. PACK :** 25

# CLUTCH - 3WHEELER

## BAJAJ AUTO 3WHEELER 4ST - 200CC (MX-LPG/CNG)



**ENDURANCE**  
Complete Solutions



**PART NO. :** 1650101701  
**APPLICATION :** CLUTCH ASSEMBLY  
**SUITABLE FOR :** BAJAJ-3W RE 205 / COMPACT/MX CNG  
**STD. PACK :** 4



**PART NO. :** 1650101801  
**APPLICATION :** CLUTCH ASSEMBLY  
**SUITABLE FOR :** BAJAJ-3W RE 205 / COMPACT/MX LPG  
**STD. PACK :** 4



**PART NO. :** 1650200739  
**APPLICATION :** HOUSING CLUTCH ASSEMBLY  
**SUITABLE FOR :** BAJAJ-3W RE 205 / COMPACT/4ST 200 MX LPG  
**STD. PACK :** 4



**PART NO. :** 165FC00375  
**APPLICATION :** FRICTION CLUTCH - (SET OF 7)  
**SUITABLE FOR :** BAJAJ-3W 4 STROKE COMPACT  
**STD. PACK :** 52 Sets



**PART NO. :** 165FC00275  
**APPLICATION :** FRICTION CLUTCH - (SET OF 7)  
**SUITABLE FOR :** BAJAJ-3W 4 STROKE COMPACT UPG  
**STD. PACK :** 52 Sets

## BAJAJ AUTO 3WHEELER 4ST (RR)



**PART NO. :** 1650100201  
**APPLICATION :** CLUTCH ASSEMBLY  
**SUITABLE FOR :** BAJAJ-3W 4 STROKE - ALL OLD MODEL  
**STD. PACK :** 4



**PART NO. :** 1650101601  
**APPLICATION :** CLUTCH ASSEMBLY  
**SUITABLE FOR :** BAJAJ-3W 175 / RE 205 UPG  
**STD. PACK :** 4



**PART NO. :** 1650301101  
**APPLICATION :** PLATE CLUTCH ASSEMBLY  
**SUITABLE FOR :** BAJAJ-3W RE 205 / COMPACT UPG  
**STD. PACK :** 4



**PART NO. :** 165FC00229  
**APPLICATION :** FRICTION CLUTCH (SET OF 1)  
**SUITABLE FOR :** BAJAJ-3W 175 / RE 205/ COMPACT  
**STD. PACK :** 364



**PART NO. :** 165FC00129  
**APPLICATION :** FRICTION CLUTCH (SET OF 1)  
**SUITABLE FOR :** BAJAJ-3W 4 STROKE UPG  
**STD. PACK :** 364



**PART NO. :** 520FR00375  
**APPLICATION :** HOLDER CLUTCH KIT - (3 HOLE)  
**SUITABLE FOR :** BAJAJ-3W 4 STROKE  
**STD. PACK :** 50



**PART NO. :** 520FN00475  
**APPLICATION :** HOLDER PLATE  
**SUITABLE FOR :** BAJAJ-3W RE 205 / COMPACT/ 4 STROKE UPG  
**STD. PACK :** 50



**PART NO. :** 165FW00233  
**APPLICATION :** HOUSING CLUTCH  
**SUITABLE FOR :** BAJAJ-3W 175 / RE 205 / COMPACT/ 4 STROKE  
**STD. PACK :** 15

# CLUTCH - 3WHEELER

## BAJAJ AUTO 3WHEELER 4ST (RR)



**ENDURANCE**  
Complete Solutions



**PART NO. :** 165FY00222  
**APPLICATION :** HUB CLUTCH  
**SUITABLE FOR :** BAJAJ-3W  
4 STROKE  
**STD. PACK :** 35



**PART NO. :** 165FY00122  
**APPLICATION :** HUB CLUTCH  
**SUITABLE FOR :** BAJAJ-3W  
175 / RE 205 / COMPACT UPG  
**STD. PACK :** 35



**PART NO. :** 520JT00475  
**APPLICATION :** PLATE CLUTCH  
**SUITABLE FOR :** BAJAJ- 3W  
4 STROKE  
**STD. PACK :** 300

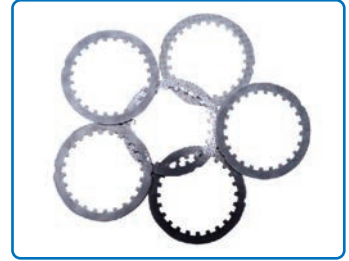

**PART NO. :** 520JT00375  
**APPLICATION :** PLATE CLUTCH  
**SUITABLE FOR :** BAJAJ-3W  
RE 205 / COMPACT/ 4 STROKE UPG  
**STD. PACK :** 300



**PART NO. :** 165PP00217  
**APPLICATION :** WHEEL CLUTCH  
**SUITABLE FOR :** BAJAJ-3W  
4 STROKE  
**STD. PACK :** 40



**PART NO. :** 165PP00117  
**APPLICATION :** WHEEL CLUTCH  
**SUITABLE FOR :** BAJAJ-3W  
4 STROKE UPG  
**STD. PACK :** 40



**PART NO. :** 520FN00575  
**APPLICATION :** HOLDER PLATE  
**SUITABLE FOR :** BAJAJ 3WH 4ST  
**STD. PACK :** 50

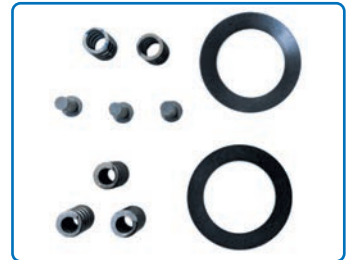

**PART NO. :** 1600200401  
**APPLICATION :** SERVICE KIT  
**SUITABLE FOR :** BAJAJ 3WH 4ST  
**STD. PACK :** 120

## PIAGGIO - 3WHEELER



**PART NO. :** 161FC00229  
**APPLICATION :** DRIVEN PLATE  
ASSEMBLY ( FRICTION CLUTCH)  
(SET OF 5)  
**SUITABLE FOR :** ATUL-SHAKTI,  
MAHINDRA - ALFA, PIAGGIO - APE  
**STD. PACK :** 225



**PART NO. :** 161CE00129  
**APPLICATION :** CLUTCH SHAFT  
**SUITABLE FOR :** ATUL-SHAKTI,  
MAHINDRA - ALFA BS II,  
PIAGGIO - APE  
**STD. PACK :** 25



**PART NO. :** 1610400201  
**APPLICATION :** ENGINE GEAR  
**SUITABLE FOR :** ATUL-SHAKTI,  
MAHINDRA - ALFA BSII,  
PIAGGIO - APE  
**STD. PACK :** 10



**PART NO. :** 520HR00575  
**APPLICATION :** PRESSURE  
PLATE OUTER  
**SUITABLE FOR :** ATUL-SHAKTI,  
MAHINDRA - ALFA, PIAGGIO - APE  
**STD. PACK :** 100



**PART NO. :** 1610104201  
**APPLICATION :** CLUTCH ASSEMBLY  
**SUITABLE FOR :** ATUL-SHAKTI,  
MAHINDRA - ALFA, PIAGGIO - APE501  
**STD. PACK :** 4



**PART NO. :** 161FC00229  
**APPLICATION :** DRIVEN PLATE  
ASSEMBLY(FRICTION CLUTCH)  
(SET OF 5)  
**SUITABLE FOR :** ATUL-SHAKTI,  
MAHINDRA - ALFA, PIAGGIO - APE501  
**STD. PACK :** 225



**PART NO. :** 520JT01275  
**APPLICATION :** DRIVING PLATE  
CLUTCH REDUCED  
(PLATE CLUTCH)  
**SUITABLE FOR :** ATUL-SHAKTI,  
MAHINDRA - ALFA, PIAGGIO - APE501  
**STD. PACK :** 100



**PART NO. :** 520HR00575  
**APPLICATION :** PRESSURE PLATE  
OUTER (PLATE CLUTCH) -  
**SUITABLE FOR :** ATUL-SHAKTI,  
MAHINDRA - ALFA, PIAGGIO - APE501  
**STD. PACK :** 100

# CLUTCH - 3WHEELER

## MAHINDRA & MAHINDRA 3WHEELER GIO (501)



**ENDURANCE**  
Complete Solutions



**PART NO. :** 1690101301  
**APPLICATION :** CLUTCH ASSEMBLY  
**SUITABLE FOR :** MAHINDRA-GIO  
**STD. PACK :** 4



**PART NO. :** 1690200839  
**APPLICATION :** HOUSING CLUTCH ASSEMBLY  
**SUITABLE FOR :** MAHINDRA-GIO  
**STD. PACK :** 4



**PART NO. :** 1690301001  
**APPLICATION :** PLATE CLUTCH ASSEMBLY  
**SUITABLE FOR :** MAHINDRA-GIO  
**STD. PACK :** 4



**PART NO. :** 160FC00401  
**APPLICATION :** FRICTION CLUTCH SET- (SET OF 6)  
**SUITABLE FOR :** MAHINDRA-GIO  
**STD. PACK :** 42



**PART NO. :** 520JT04675  
**APPLICATION :** PLATE CLUTCH  
**SUITABLE FOR :** MAHINDRA-GIO  
**STD. PACK :** 75

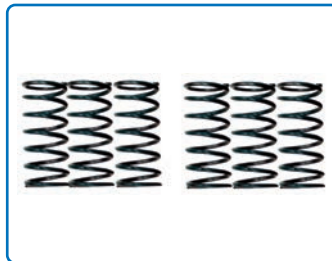

**PART NO. :** 520MD04275  
**APPLICATION :** SPRING CLUTCH (SET OF 6)  
**SUITABLE FOR :** MAHINDRA-GIO  
**STD. PACK :** 720



**PART NO. :** 169FY01126  
**APPLICATION :** HUB CLUTCH  
**SUITABLE FOR :** MAHINDRA GIO  
**STD. PACK :** 4



**PART NO. :** 169PP00475  
**APPLICATION :** WHEEL CLUTCH  
**SUITABLE FOR :** MAHINDRA GIO  
**STD. PACK :** 30

## MAHINDRA & MAHINDRA 3WHEELER BS-III



**PART NO. :** 1610102101  
**APPLICATION :** CLUTCH ASSEMBLY  
**SUITABLE FOR :** MAHINDRA BS-III  
**STD. PACK :** 4



**PART NO. :** 161FW00933  
**APPLICATION :** HOUSING WITH BUSH  
**SUITABLE FOR :** MAHINDRA BS-III  
**STD. PACK :** 15



**PART NO. :** 161CE00301  
**APPLICATION :** CLUTCH SHAFT  
**SUITABLE FOR :** MAHINDRA BS-III  
**STD. PACK :** 25



**PART NO. :** 1610400701  
**APPLICATION :** ENGINE GEAR  
**SUITABLE FOR :** MAHINDRA BS-III  
**STD. PACK :** 10



**PART NO. :** 160FC00301  
**APPLICATION :** FRICTION CLUTCH & FORMED PLATE SET OF 7  
**SUITABLE FOR :** MAHINDRA BS-III  
**STD. PACK :** 45



**PART NO. :** 160JT00501  
**APPLICATION :** PLATE CLUTCH & PRESSURE PLATE OUTER SET  
**SUITABLE FOR :** MAHINDRA BS-III  
**STD. PACK :** 60

# CLUTCH - 3WHEELER

## MAHINDRA & MAHINDRA 3WHEELER BS-II/ ATUL AUTO



**ENDURANCE**  
Complete Solutions



**PART NO. :** 520JT01275  
**APPLICATION :** DRIVING PLATE CLUTCH REDUCED (PLATE CLUTCH)  
**SUITABLE FOR :** ATUL-SHAKTI, MAHINDRA - ALFA (BS-II), PIAGGIO - APE  
**STD. PACK :** 100



**PART NO. :** 520HR00575  
**APPLICATION :** PRESSURE PLATE OUTER  
**SUITABLE FOR :** ATUL-SHAKTI, MAHINDRA - ALFA (BS-II), PIAGGIO - APE  
**STD. PACK :** 100

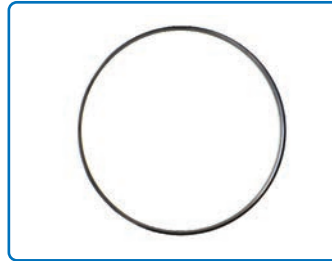

**PART NO. :** 520KQ00475  
**APPLICATION :** BOX CLUTCH RING  
**SUITABLE FOR :** ATUL-SHAKTI, MAHINDRA - ALFA (BS-II), PIAGGIO - APE  
**STD. PACK :** 50

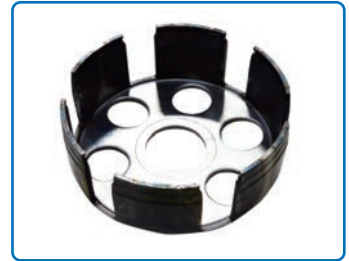

**PART NO. :** 520FW01175  
**APPLICATION :** BOX CLUTCH  
**SUITABLE FOR :** ATUL-SHAKTI, MAHINDRA - ALFA (BS-II), PIAGGIO - APE  
**STD. PACK :** 20



**PART NO. :** 161CE00129  
**APPLICATION :** CLUTCH SHAFT  
**SUITABLE FOR :** ATUL-SHAKTI, MAHINDRA - ALFA (BS-II), PIAGGIO - APE  
**STD. PACK :** 25



**PART NO. :** 520KQ00175  
**APPLICATION :** CIRCLIP CLUTCH  
**SUITABLE FOR :** ATUL-SHAKTI, MAHINDRA - ALFA (BS-II), PIAGGIO - APE  
**STD. PACK :** 100



**PART NO. :** 1610101501  
**APPLICATION :** CLUTCH ASSEMBLY  
**SUITABLE FOR :** ATUL-SHAKTI, MAHINDRA - ALFA (BS-II), PIAGGIO - APE  
**STD. PACK :** 4



**PART NO. :** 1610400201  
**APPLICATION :** ENGINE GEAR  
**SUITABLE FOR :** ATUL-SHAKTI, MAHINDRA - ALFA (BS-II), PIAGGIO - APE  
**STD. PACK :** 10



**PART NO. :** 520CL00175  
**APPLICATION :** CUP FOR SPRING  
**SUITABLE FOR :** ATUL-SHAKTI, MAHINDRA - ALFA (BS-II), PIAGGIO - APE  
**STD. PACK :** 300



**PART NO. :** 161FC00229  
**APPLICATION :** DRIVEN PLATE ASSEMBLY (FRICTION CLUTCH) (SET OF 5)  
**SUITABLE FOR :** ATUL-SHAKTI, MAHINDRA - ALFA (BS-II), PIAGGIO - APE  
**STD. PACK :** 225

## 3 WHEELER TVS MOTORS - TVS KING



**PART NO. :** 160FC00701  
**APPLICATION :** FRICTION CLUTCH (SET OF 6)  
**SUITABLE FOR :** TVS-KING 2 STROKE  
**STD. PACK :** 45



**PART NO. :** 160FC00801  
**APPLICATION :** FRICTION CLUTCH (SET OF 5)  
**SUITABLE FOR :** TVS-KING 4 STROKE  
**STD. PACK :** 48

# CLUTCH - 2WHEELER



**ENDURANCE**  
Complete Solutions

## BAJAJ AUTO - CT 100 S&S DELUXE



**PART NO. :** 1610101201  
**APPLICATION :** CLUTCH ASSEMBLY  
**SUITABLE FOR :** BAJAJ CT-S&S DELUXE  
**STD. PACK :** 4



**PART NO. :** 1610300101  
**APPLICATION :** PLATE CLUTCH ASSEMBLY  
**SUITABLE FOR :** BAJAJ CT-S&S DELUXE  
**STD. PACK :** 4

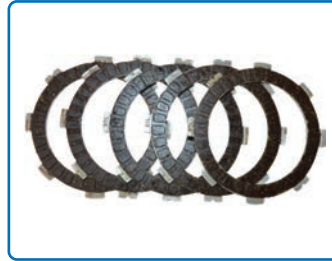

**PART NO. :** 161FC00101  
**APPLICATION :** FRICTION CLUTCH  
**SUITABLE FOR :** BAJAJ CT-S&S DELUXE  
**STD. PACK :** 260



**PART NO. :** 1610201239  
**APPLICATION :** HOUSING CLUTCH ASSEMBLY  
**SUITABLE FOR :** BAJAJ CT-S&S DELUXE  
**STD. PACK :** 4



**PART NO. :** 161FZ00522  
**APPLICATION :** HUB CLUTCH  
**SUITABLE FOR :** BAJAJ CT-S&S DELUXE  
**STD. PACK :** 30



**PART NO. :** 520JT01575  
**APPLICATION :** PLATE CLUTCH  
**SUITABLE FOR :** BAJAJ CT-S&S DELUXE  
**STD. PACK :** 120



**PART NO. :** 161PP00117  
**APPLICATION :** WHEEL CLUTCH  
**SUITABLE FOR :** BAJAJ CT-S&S DELUXE  
**STD. PACK :** 30

## BAJAJ AUTO - PLATINA



**PART NO. :** 1610102701  
**APPLICATION :** CLUTCH ASSEMBLY  
**SUITABLE FOR :** BAJAJ PLATINA, BOXER 100  
**STD. PACK :** 4



**PART NO. :** 1610300801  
**APPLICATION :** PLATE CLUTCH ASSEMBLY  
**SUITABLE FOR :** BAJAJ PLATINA, BOXER 100  
**STD. PACK :** 4



**PART NO. :** 161FZ00522  
**APPLICATION :** HUB CLUTCH  
**SUITABLE FOR :** BAJAJ PLATINA, BOXER 100  
**STD. PACK :** 30



**PART NO. :** 1610200139  
**APPLICATION :** HOUSING CLUTCH ASSEMBLY  
**SUITABLE FOR :** BAJAJ PLATINA, BOXER 100  
**STD. PACK :** 4



**PART NO. :** 161PP00117  
**APPLICATION :** WHEEL CLUTCH  
**SUITABLE FOR :** BAJAJ PLATINA, BOXER 100  
**STD. PACK :** 30

# CLUTCH - 2WHEELER

## BAJAJ AUTO 4ST - BOXER 100/AT/CT



**ENDURANCE**  
Complete Solutions



**PART NO. :** 1620100101  
**APPLICATION :** CLUTCH ASSEMBLY  
**SUITABLE FOR :** BAJAJ-4S CHAMPION, BOXER 100/AT/CT  
**STD. PACK :** 4

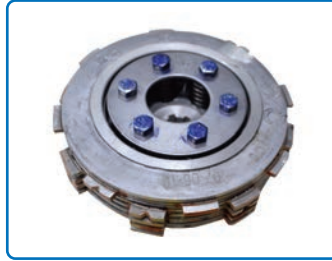

**PART NO. :** 1620300101  
**APPLICATION :** PLATE CLUTCH ASSEMBLY  
**SUITABLE FOR :** BAJAJ-4S CHAMPION, BOXER 100/AT/CT  
**STD. PACK :** 4



**PART NO. :** 162FC00129  
**APPLICATION :** FRICTION CLUTCH (SET OF 4)  
**SUITABLE FOR :** BAJAJ-4S CHAMPION, BOXER 100/AT/CT  
**STD. PACK :** 208

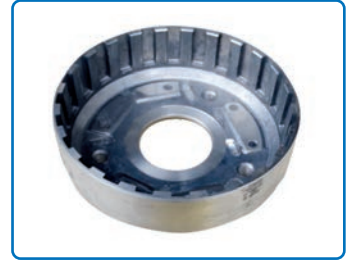

**PART NO. :** 162FW00117  
**APPLICATION :** HOUSING CLUTCH  
**SUITABLE FOR :** BAJAJ-4S CHAMPION, BOXER 100/AT/CT  
**STD. PACK :** 15



**PART NO. :** 1620200139  
**APPLICATION :** HOUSING CLUTCH ASSEMBLY  
**SUITABLE FOR :** BAJAJ-4S CHAMPION, BOXER 100/AT/CT  
**STD. PACK :** 4



**PART NO. :** 162FY00117  
**APPLICATION :** HUB CLUTCH WITH INSERT  
**SUITABLE FOR :** BAJAJ-4S CHAMPION, BOXER 100/AT/CT  
**STD. PACK :** 30



**PART NO. :** 520JT01475  
**APPLICATION :** PLATE CLUTCH  
**SUITABLE FOR :** BAJAJ-4S CHAMPION, BOXER 100/AT/CT  
**STD. PACK :** 105



**PART NO. :** 162PP00117  
**APPLICATION :** WHEEL CLUTCH  
**SUITABLE FOR :** BAJAJ-4S CHAMPION, BOXER 100/AT/CT  
**STD. PACK :** 30



**PART NO. :** 1600200301  
**APPLICATION :** SERVICE KIT CLBR /4ST  
**SUITABLE FOR :** BAJAJ CALIBER /4ST  
**STD. PACK :** 50

## BAJAJ AUTO VIKRANT



**PART NO. :** 1650103201  
**APPLICATION :** CLUTCH ASSEMBLY  
**SUITABLE FOR :** BAJAJ-V 15  
**STD. PACK :** 4



**PART NO. :** 1650301701  
**APPLICATION :** PLATE CLUTCH ASSEMBLY  
**SUITABLE FOR :** BAJAJ-V 15  
**STD. PACK :** 4



**PART NO. :** 165FZ00422  
**APPLICATION :** HUB CLUTCH  
**SUITABLE FOR :** BAJAJ-V 15  
**STD. PACK :** 30

# CLUTCH - 2WHEELER

## BAJAJ AUTO - DISCOVER



**ENDURANCE**  
Complete Solutions



**PART NO. :** 169FW00117  
**APPLICATION :** HOUSING CLUTCH  
**SUITABLE FOR :** BAJAJ DISCOVER  
**STD. PACK :** 15



**PART NO. :** 1610102901  
**APPLICATION :** CLUTCH ASSEMBLY  
**SUITABLE FOR :** BAJAJ DISCOVER 125  
**STD. PACK :** 4

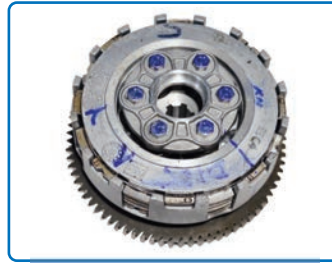

**PART NO. :** 1610103501  
**APPLICATION :** CLUTCH ASSEMBLY  
**SUITABLE FOR :** BAJAJ DISCOVER 150  
**STD. PACK :** 4



**PART NO. :** 169FY00126  
**APPLICATION :** HUB CLUTCH (WITH INSERT)  
**SUITABLE FOR :** BAJAJ DISCOVER 135  
**STD. PACK :** 30



**PART NO. :** 161FZ00422  
**APPLICATION :** HUB CLUTCH (WITHOUT INSERT)  
**SUITABLE FOR :** BAJAJ DISCOVER 100/125, BOXER 100  
**STD. PACK :** 30



**PART NO. :** 1610300701  
**APPLICATION :** PLATE CLUTCH ASSEMBLY  
**SUITABLE FOR :** BAJAJ DISCOVER 125  
**STD. PACK :** 4



**PART NO. :** 1690300701  
**APPLICATION :** PLATE CLUTCH ASSEMBLY  
**SUITABLE FOR :** BAJAJ DISCOVER 125/135/150/150 ST  
**STD. PACK :** 4



**PART NO. :** 520FN00275  
**APPLICATION :** HOLDER PLATE  
**SUITABLE FOR :** BAJAJ DISCOVER  
**STD. PACK :** 50



**PART NO. :** 1690300101  
**APPLICATION :** PLATE CLUTCH ASSEMBLY  
**SUITABLE FOR :** BAJAJ DISCOVER  
**STD. PACK :** 4



**PART NO. :** 169PP00117  
**APPLICATION :** WHELL CLUTCH  
**SUITABLE FOR :** BAJAJ DISCOVER 135, PULSAR 150/180  
**STD. PACK :** 30

## BAJAJ AUTO - PULSAR UPGRADE



**PART NO. :** 169FC00229  
**APPLICATION :** FRICTION CLUTCH  
**SUITABLE FOR :** BAJAJ PULSAR UPG  
**STD. PACK :** 240



**PART NO. :** 169FW00526  
**APPLICATION :** HOUSING CLUTCH  
**SUITABLE FOR :** BAJAJ PULSAR UPG  
**STD. PACK :** 15



**PART NO. :** 169FY00626  
**APPLICATION :** HUB CLUTCH  
**SUITABLE FOR :** BAJAJ PULSAR UPG  
**STD. PACK :** 30



**PART NO. :** 520JT00275  
**APPLICATION :** PLATE CLUTCH  
**SUITABLE FOR :** BAJAJ PULSAR UPG  
**STD. PACK :** 75



# CLUTCH - 2WHEELER

## BAJAJ AUTO - PULSAR



**ENDURANCE**  
Complete Solutions



**PART NO. :** 169FW00126  
**APPLICATION :** HOUSING CLUTCH  
**SUITABLE FOR :** BAJAJ PULSAR 150 (OLD)  
**STD. PACK :** 15



**PART NO. :** 169FW00526  
**APPLICATION :** HOUSING CLUTCH  
**SUITABLE FOR :** BAJAJ PULSAR 180  
**STD. PACK :** 15



**PART NO. :** 169FY00826  
**APPLICATION :** HUB CLUTCH  
**SUITABLE FOR :** BAJAJ PULSAR 150  
**STD. PACK :** 30



**PART NO. :** 169FY00426  
**APPLICATION :** HUB CLUTCH  
**SUITABLE FOR :** BAJAJ PULSAR 180  
**STD. PACK :** 30



**PART NO. :** 1690300201  
**APPLICATION :** PLATE CLUTCH ASSEMBLY  
**SUITABLE FOR :** BAJAJ PULSAR 150 (OLD)  
**STD. PACK :** 4



**PART NO. :** 169PP00117  
**APPLICATION :** WHELL CLUTCH  
**SUITABLE FOR :** BAJAJ DISCOVER 135, PULSAR 150/180  
**STD. PACK :** 30



**PART NO. :** 1650103101  
**APPLICATION :** CLUTCH ASSY  
**SUITABLE FOR :** BAJAJ PULSAR 125  
**STD. PACK :** 4

## BAJAJ AUTO - PULSAR 150 UPGRADE -3



**PART NO. :** 520FW02502  
**APPLICATION :** HOUSING CLUTCH  
**SUITABLE FOR :** BAJAJ PULSAR UPG-3  
**STD. PACK :** 15



**PART NO. :** 520FY02375  
**APPLICATION :** HUB CLUTCH  
**SUITABLE FOR :** BAJAJ PULSAR UPG-3  
**STD. PACK :** 30



**PART NO. :** 520PP04375  
**APPLICATION :** WHEEL CLUTCH  
**SUITABLE FOR :** BAJAJ PULSAR UPG-3  
**STD. PACK :** 30



**PART NO. :** 520FC02375  
**APPLICATION :** FRICTION CLUTCH SET  
**SUITABLE FOR :** BAJAJ PULSAR UPG-3  
**STD. PACK :** 48

# CLUTCH - 2WHEELER

## BAJAJ AUTO - PULSAR 150 UPGRADE -4



**ENDURANCE**  
Complete Solutions



**PART NO. :** 1690300801  
**APPLICATION :** PLATE CLUTCH ASSEMBLY - BAJAJ - PULSAR 150 (BSIII)  
**SUITABLE FOR :** BAJAJ PULSAR (BSIII) UPG-4  
**STD. PACK :** 4



**PART NO. :** 1690101101  
**APPLICATION :** CLUTCH ASSEMBLY  
**SUITABLE FOR :** BAJAJ PULSAR (BSIII) UPG-4  
**STD. PACK :** 4



**PART NO. :** 169JT06375  
**APPLICATION :** PLATE CLUTCH SET  
**SUITABLE FOR :** BAJAJ PULSAR (BSIII) UPG-4  
**STD. PACK :** 30



**PART NO. :** 169FZ00322  
**APPLICATION :** HUB CLUTCH PULSAR UG-4  
**SUITABLE FOR :** BAJAJ PULSAR (BSIII) UPG-4  
**STD. PACK :** 30



**PART NO. :** 520AM00289  
**APPLICATION :** FRICTION CLUTCH - (SET OF 6)  
**SUITABLE FOR :** BAJAJ PULSAR 150 (UG4)  
**STD. PACK :** 30



**PART NO. :** 520FC02475  
**APPLICATION :** FRICTION CLUTCH - (SET OF 5)  
**SUITABLE FOR :** BAJAJ PULSAR 150 (UG4)  
**STD. PACK :** 48

## BAJAJ AUTO - XCD 125CC



**PART NO. :** 165FC00429  
**APPLICATION :** FRICTION CLUTCH  
**SUITABLE FOR :** BAJAJ-XCD 125  
**STD. PACK :** 208



**PART NO. :** 1650100701  
**APPLICATION :** CLUTCH ASSEMBLY  
**SUITABLE FOR :** BAJAJ XCD 125/135  
**STD. PACK :** 4



**PART NO. :** 165FC00329  
**APPLICATION :** FRICTION CLUTCH REDUCE  
**SUITABLE FOR :** BAJAJ-XCD 125  
**STD. PACK :** 225



**PART NO. :** 165FW00333  
**APPLICATION :** HOUSING CLUTCH  
**SUITABLE FOR :** BAJAJ-XCD 125  
**STD. PACK :** 15



**PART NO. :** 1650300501  
**APPLICATION :** PLATE CLUTCH ASSEMBLY  
**SUITABLE FOR :** BAJAJ-XCD 135  
**STD. PACK :** 4



**PART NO. :** 1650200339  
**APPLICATION :** HOUSING CLUTCH ASSEMBLY  
**SUITABLE FOR :** BAJAJ-XCD 125  
**STD. PACK :** 4



**PART NO. :** 165FZ00222  
**APPLICATION :** HUB CLUTCH  
**SUITABLE FOR :** BAJAJ-XCD 125  
**STD. PACK :** 30



**PART NO. :** 520JT00675  
**APPLICATION :** PLATE CLUTCH  
**SUITABLE FOR :** BAJAJ-XCD 125  
**STD. PACK :** 120

# CLUTCH - 2WHEELER

## BAJAJ AUTO - XCD 125CC



**ENDURANCE**  
Complete Solutions

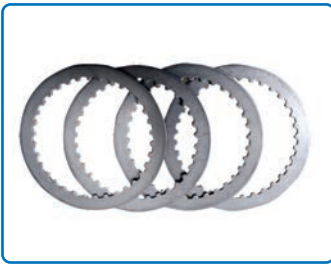

**PART NO. :** 520JT05075  
**APPLICATION :** PLATE CLUTCH  
**SUITABLE FOR :** BAJAJ-XCD 135  
**STD. PACK :** 120



**PART NO. :** 520PL03575  
**APPLICATION :** PLATE JUDDER  
**SUITABLE FOR :** BAJAJ-XCD 125  
**STD. PACK :** 50



**PART NO. :** 165PP00517  
**APPLICATION :** WHELL CLUTCH  
**SUITABLE FOR :** BAJAJ-XCD 125  
**STD. PACK :** 30

## BAJAJ AUTO - BOXER 150CC



**PART NO. :** 1650101201  
**APPLICATION :** CLUTCH ASSEMBLY  
**SUITABLE FOR :** BAJAJ BOXER 150  
**STD. PACK :** 4



**PART NO. :** 165FZ00322  
**APPLICATION :** HUB CLUTCH  
**SUITABLE FOR :** BAJAJ BOXER 150  
**STD. PACK :** 30



**PART NO. :** 165FW00333  
**APPLICATION :** HOUSING CLUTCH  
**SUITABLE FOR :** BAJAJ BOXER 150  
**STD. PACK :** 15



**PART NO. :** 165FC01829  
**APPLICATION :** FRICTION CLUTCH - (SET OF 5)  
**SUITABLE FOR :** BAJAJ BOXER 150  
**STD. PACK :** 260



**PART NO. :** 165PP00517  
**APPLICATION :** WHELL CLUTCH  
**SUITABLE FOR :** BAJAJ BOXER 150  
**STD. PACK :** 30

# CLUTCH - 2WHEELER

## BAJAJ AUTO - DISCOVER 100CC



**ENDURANCE**  
Complete Solutions



**PART NO. :** 1610100501  
**APPLICATION :** CLUTCH ASSEMBLY  
**SUITABLE FOR :** BAJAJ DISCOVER 100  
**STD. PACK :** 4



**PART NO. :** 1610200239  
**APPLICATION :** HOUSING CLUTCH ASSEMBLY  
**SUITABLE FOR :** BAJAJ DISCOVER 100  
**STD. PACK :** 4



**PART NO. :** 1610300301  
**APPLICATION :** CLUTCH PLATE ASSEMBLY  
**SUITABLE FOR :** BAJAJ DISCOVER 100  
**STD. PACK :** 4

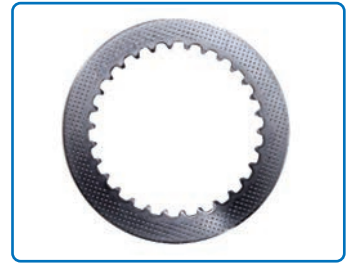

**PART NO. :** 520JT00175  
**APPLICATION :** PLATE CLUTCH  
**SUITABLE FOR :** BAJAJ DISCOVER 100  
**STD. PACK :** 75



**PART NO. :** 161FW00233  
**APPLICATION :** HOUSING CLUTCH  
**SUITABLE FOR :** BAJAJ DISCOVER 100  
**STD. PACK :** 15



**PART NO. :** 161FZ00322  
**APPLICATION :** HUB CLUTCH  
**SUITABLE FOR :** BAJAJ DISCOVER 100  
**STD. PACK :** 30



**PART NO. :** 161PP00217  
**APPLICATION :** WHEEL CLUTCH  
**SUITABLE FOR :** BAJAJ DISCOVER 100  
**STD. PACK :** 30

## SUZUKI MOTORCYCLE



**PART NO. :** 520FC01602  
**APPLICATION :** FRICTION CLUTCH - (SET OF 4)  
**SUITABLE FOR :** SUZUKI-HEAT, ZEUS  
**STD. PACK :** 192



**PART NO. :** 165JT00575  
**APPLICATION :** PLATE CLUTCH SET - (SET OF 4)  
**SUITABLE FOR :** SUZUKI-GIXXER  
**STD. PACK :** 30



**PART NO. :** 165FC00829  
**APPLICATION :** FRICTION CLUTCH - (SET OF 4)  
**SUITABLE FOR :** LML-FREEDOM  
**STD. PACK :** 208

## LML MOTORS

# CLUTCH - 2WHEELER

HERO MOTO CORP



**PART NO. :** C2JT00675M  
**APPLICATION :** PLATE CLUTCH SET - (SET OF 3)  
**SUITABLE FOR :** HERO SPLENDOR  
**STD. PACK :** 35



**PART NO. :** 165FC03629  
**APPLICATION :** FRICTION CLUTCH - (MODIFIED)(SET OF 4)  
**SUITABLE FOR :** HERO SPLENDOR  
**STD. PACK :** 208



**PART NO. :** 520FC01002  
**APPLICATION :** FRICTION CLUTCH - (SET OF 5)  
**SUITABLE FOR :** HERO AMBITION, CBZ  
**STD. PACK :** 240



**PART NO. :** 520FC01102  
**APPLICATION :** FRICTION CLUTCH - (SET OF 5)  
**SUITABLE FOR :** HERO GLAMOUR, SUPER SPLENDOR  
**STD. PACK :** 240



**PART NO. :** 520FY01102  
**APPLICATION :** HUB CLUTCH  
**SUITABLE FOR :** HERO KARIZMA  
**STD. PACK :** 30



**PART NO. :** 520FY01875  
**APPLICATION :** HUB CLUTCH  
**SUITABLE FOR :** HERO-CD DAWN, DELUXE, PASSION, PASSION PRO, SPLENDOR, SPLENDOR PLUS  
**STD. PACK :** 30



**PART NO. :** 520PP01075  
**APPLICATION :** WHEEL CLUTCH  
**SUITABLE FOR :** HERO-CD DAWN, DELUXE, PASSION, PASSION PRO, SPLENDOR, SPLENDOR PLUS  
**STD. PACK :** 30



**PART NO. :** 520FY02202  
**APPLICATION :** HUB CLUTCH  
**SUITABLE FOR :** HERO GLAMOUR, SUPER SPLENDOR  
**STD. PACK :** 30



**PART NO. :** 520PP01202  
**APPLICATION :** WHEEL CLUTCH  
**SUITABLE FOR :** HERO GLAMOUR, SUPER SPLENDOR  
**STD. PACK :** 30



**PART NO. :** 520PP01402  
**APPLICATION :** WHEEL CLUTCH  
**SUITABLE FOR :** HERO KARIZMA/ZMR  
**STD. PACK :** 30



**PART NO. :** 520FW01702  
**APPLICATION :** HOUSING CLUTCH  
**SUITABLE FOR :** HERO-CD DAWN, CD DELUXE, PASSION, PASSION PRO, SPLENDOR, SPLENDOR PLUS  
**STD. PACK :** 15



**PART NO. :** C20301001M  
**APPLICATION :** PLATE CLUTCH ASSY.  
**SUITABLE FOR :** HERO SPLENDOR, HF DLX, CD100, DLX, SS, DOWAN, PASSION,  
**STD. PACK :** 8

# CLUTCH - 2WHEELER

## ROYAL ENFIELD



**ENDURANCE**  
Complete Solutions



**PART NO. :** 16F0100201  
**APPLICATION :** CLUTCH ASSEMBLY - 4 SPEED - 5SPLINE (4PLATE)  
**SUITABLE FOR :** ROYAL ENFIELD ELECTRA  
**STD. PACK :** 4



**PART NO. :** 16F0100101  
**APPLICATION :** CLUTCH ASSEMBLY - 4 SPEED - 5SPLINE (5PLATE)  
**SUITABLE FOR :** ROYAL ENFIELD ELECTRA  
**STD. PACK :** 4



**PART NO. :** 16F0100301  
**APPLICATION :** CLUTCH ASSEMBLY - 5 SPEED - 16SPLINE (4PLATE)  
**SUITABLE FOR :** ROYAL ENFIELD ELECTRA  
**STD. PACK :** 4



**PART NO. :** 16F0100401  
**APPLICATION :** CLUTCH ASSEMBLY - 5 SPEED - 16SPLINE (5PLATE)  
**SUITABLE FOR :** ROYAL ENFIELD ELECTRA  
**STD. PACK :** 4



**PART NO. :** 16J0100101  
**APPLICATION :** CLUTCH ASSEMBLY - (6 PLATE)  
**SUITABLE FOR :** ROYAL ENFIELD CLASSIC  
**STD. PACK :** 4



**PART NO. :** 16J0100201  
**APPLICATION :** CLUTCH ASSEMBLY - (7 PLATE)  
**SUITABLE FOR :** ROYAL ENFIELD CLASSIC  
**STD. PACK :** 4



**PART NO. :** 16FFC00829  
**APPLICATION :** FRICTION CLUTCH - (SET OF 1)  
**SUITABLE FOR :** ROYAL ENFIELD ELECTRA  
**STD. PACK :** 24



**PART NO. :** 16FFC00229  
**APPLICATION :** FRICTION CLUTCH BONDED -(SET OF 1)  
**SUITABLE FOR :** ROYAL ENFIELD ELECTRA  
**STD. PACK :** 24



**PART NO. :** 16JFC00129  
**APPLICATION :** FRICTION CLUTCH - (6PLATE / 7 PLATE) (SET OF 1)  
**SUITABLE FOR :** ROYAL ENFIELD ELECTRA  
**STD. PACK :** 24



**PART NO. :** 16JFZ00175  
**APPLICATION :** HUB CLUTCH - (6 PLATE / 7 PLATE)  
**SUITABLE FOR :** ROYAL ENFIELD ELECTRA  
**STD. PACK :** 15



**PART NO. :** 16JPP00117  
**APPLICATION :** WHEEL CLUTCH - (6 PLATE)  
**SUITABLE FOR :** ROYAL ENFIELD ELECTRA  
**STD. PACK :** 15



**PART NO. :** 16JPP00217  
**APPLICATION :** WHEEL CLUTCH - (7 PLATE)  
**SUITABLE FOR :** ROYAL ENFIELD ELECTRA  
**STD. PACK :** 15

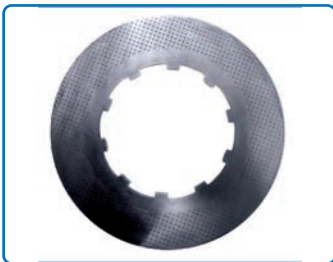

**PART NO. :** 520JT02275  
**APPLICATION :** PLATE CLUTCH FLAT  
**SUITABLE FOR :** ROYAL ENFIELD ELECTRA  
**STD. PACK :** 25



**PART NO. :** 520JT02075  
**APPLICATION :** PLATE CLUTCH FORM 4 PLATE  
**SUITABLE FOR :** ROYAL ENFIELD ELECTRA  
**STD. PACK :** 25

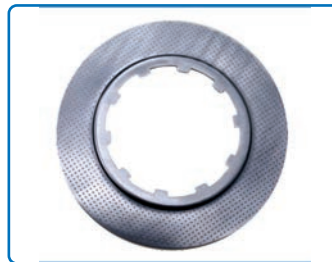

**PART NO. :** 520JT01175  
**APPLICATION :** PLATE CLUTCH STEEL  
**SUITABLE FOR :** ROYAL ENFIELD ELECTRA  
**STD. PACK :** 25



**PART NO. :** 160JB00301  
**APPLICATION :** BALL CAGE KIT  
**SUITABLE FOR :** ROYAL ENFIELD ELECTRA  
**STD. PACK :** 50

# CLUTCH - 2WHEELER

## ROYAL ENFIELD



**ENDURANCE**  
Complete Solutions



**PART NO. :** 16F0200101  
**APPLICATION :** HOUSING  
CLUTCH ASSY  
**SUITABLE FOR :** ROYAL ENFIELD  
ELECTRA  
**STD. PACK :** 4



**PART NO. :** 16FFN00939  
**APPLICATION :** CLUTCH CAPE  
**SUITABLE FOR :** ASSY ROYAL  
ENFIELD ELECTRA  
**STD. PACK :** 50



**PART NO. :** 520JT01075  
**APPLICATION :** CLUTCH DISC  
4PLATE  
**SUITABLE FOR :** ROYAL ENFIELD  
ELECTRA  
**STD. PACK :** 25



**PART NO. :** 520QZ00275  
**APPLICATION :** DUPLEX  
SPROCKET  
**SUITABLE FOR :** ROYAL ENFIELD  
ELECTRA  
**STD. PACK :** 5



**PART NO. :** 16FFY00122  
**APPLICATION :** CLUTCH  
CENTER SUB ASSY  
**SUITABLE FOR :** ROYAL ENFIELD  
ELECTRA  
**STD. PACK :** 4



**PART NO. :** C20100301M  
**APPLICATION :** CLUTCH  
ASSEMBLY  
**SUITABLE FOR :** ROYAL  
ENFIELD-HIMALAYAN  
**STD. PACK :** 4



**PART NO. :** C2PP00375M  
**APPLICATION :** WHEEL CLUTCH  
**SUITABLE FOR :** ROYAL  
ENFIELD-HIMALAYAN  
**STD. PACK :** 8



**PART NO. :** C2FY00275M  
**APPLICATION :** HUB CLUTCH  
**SUITABLE FOR :** ROYAL  
ENFIELD-HIMALAYAN  
**STD. PACK :** 8

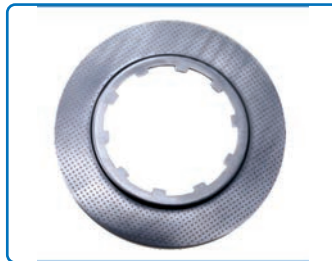

**PART NO. :** 16LJT09175  
**APPLICATION :** PLATE CLUTCH  
KIT - (SET OF 6)  
**SUITABLE FOR :** ROYAL  
ENFIELD-HIMALAYAN  
**STD. PACK :** 12



**PART NO. :** 16LFC00275  
**APPLICATION :** FRICTION  
CLUTCH KIT - (SET OF 6)  
**SUITABLE FOR :** ROYAL  
ENFIELD-HIMALAYAN  
**STD. PACK :** 12

# CLUTCH - 2WHEELER



**ENDURANCE**  
Complete Solutions

## YAMAHA MOTOR



**PART NO. :** 167FC00229  
**APPLICATION :** FRICTION CLUTCH  
**SUITABLE FOR :** YAMAHA RX 100  
**STD. PACK :** 260



**PART NO. :** 520PP00902  
**APPLICATION :** WHEEL CLUTCH  
**SUITABLE FOR :** YAMAHA RX 135  
**STD. PACK :** 30



**PART NO. :** 165JT00675  
**APPLICATION :** PLATE CLUTCH (SET OF 3)  
**SUITABLE FOR :** YAMAHA-FZ  
**STD. PACK :** 35



**PART NO. :** 520FY01602  
**APPLICATION :** HUB CLUTCH  
**SUITABLE FOR :** YAMAHA RX 135  
**STD. PACK :** 30



**PART NO. :** 520FY01702  
**APPLICATION :** HUB CLUTCH (5 PLATE)  
**SUITABLE FOR :** YAMAHA-CRUX, ENTICER, GLADIATOR, YBX  
**STD. PACK :** 30



**PART NO. :** 520PP01302  
**APPLICATION :** WHEEL CLUTCH (4/5 PLATE)  
**SUITABLE FOR :** YAMAHA-CRUX, LIBERO  
**STD. PACK :** 30



**PART NO. :** 520FY01902  
**APPLICATION :** HUB CLUTCH  
**SUITABLE FOR :** YAMAHA-FZ, FZS,FAZER  
**STD. PACK :** 30



**PART NO. :** 520PP01602  
**APPLICATION :** WHEEL CLUTCH (5 PLATE)  
**SUITABLE FOR :** YAMAHA-CRUX, ENTICER, GLADIATOR, YBX  
**STD. PACK :** 30



**PART NO. :** 520PP01702  
**APPLICATION :** WHEEL CLUTCH  
**SUITABLE FOR :** YAMAHA-FZ, FZS,FAZER  
**STD. PACK :** 30



**PART NO. :** 520FY02002  
**APPLICATION :** HUB CLUTCH (4/5 PLATE)  
**SUITABLE FOR :** YAMAHA-CRUX, LIBERO  
**STD. PACK :** 30



**PART NO. :** 520FY02102  
**APPLICATION :** HUB CLUTCH  
**SUITABLE FOR :** YAMAHA RX 100  
**STD. PACK :** 30



**PART NO. :** 520FW02202  
**APPLICATION :** HOUSING CLUTCH  
**SUITABLE FOR :** YAMAHA-CRUX, CRUX R, ENTICER, LIBERO  
**STD. PACK :** 15

## HONDA MOTORCYCLE AND SCOOTER



**PART NO. :** 520PP04175  
**APPLICATION :** WHEEL CLUTCH  
HONDA - SHINE, STUNNER  
**SUITABLE FOR :** HONDA-SHINE, STUNNER  
**STD. PACK :** 30



**PART NO. :** 520FZ00775  
**APPLICATION :** HUB CLUTCH  
HONDA - SHINE  
**SUITABLE FOR :** HONDA-SHINE  
**STD. PACK :** 30



**PART NO. :** 165JT00275  
**APPLICATION :** PLATE CLUTCH  
HONDA - UNICORN (SET OF 4)  
**SUITABLE FOR :** HONDA-UNICORN  
**STD. PACK :** 30



**PART NO. :** 165JT00175  
**APPLICATION :** PLATE CLUTCH  
HONDA - SHINE (SET OF 3)  
**SUITABLE FOR :** HONDA-SHINE  
**STD. PACK :** 35



# CLUTCH - 2WHEELER

## HONDA MOTORCYCLE AND SCOOTER



**ENDURANCE**  
Complete Solutions



**PART NO. :** 165JT00375  
**APPLICATION :** PLATE CLUTCH SET - HONDA - TWISTER (SET OF 3)  
**SUITABLE FOR :** HONDA-TWISTER  
**STD. PACK :** 35



**PART NO. :** 520FC01802  
**APPLICATION :** FRICTION CLUTCH - HONDA - ETERNO (SET OF 5)  
**SUITABLE FOR :** HONDA-ETERNO  
**STD. PACK :** 240



**PART NO. :** 520FC02502  
**APPLICATION :** FRICTION CLUTCH - HONDA - SHINE (SET OF 4)  
**SUITABLE FOR :** HONDA-SHINE  
**STD. PACK :** 192



**PART NO. :** 520FC01902  
**APPLICATION :** FRICTION CLUTCH - HONDA - UNICORN (SET OF 5)  
**SUITABLE FOR :** HONDA-UNICORN  
**STD. PACK :** 240



**PART NO. :** 165FZ00522  
**APPLICATION :** HUB CLUTCH BROACHED  
**SUITABLE FOR :** HONDA-CD-110  
**STD. PACK :** 30



**PART NO. :** 165PP00817  
**APPLICATION :** WHEEL CLUTCH  
**SUITABLE FOR :** HONDA-CD-110  
**STD. PACK :** 30



**PART NO. :** 165JT07752  
**APPLICATION :** PLATE CLUTCH (SET OF 3)  
**SUITABLE FOR :** HONDA-CD-110  
**STD. PACK :** 22



**PART NO. :** 160FC00601  
**APPLICATION :** FRICTION CLUTCH - (SET OF 4)  
**SUITABLE FOR :** HONDA TWISTER  
**STD. PACK :** 225



**PART NO. :** 165FW00833  
**APPLICATION :** HOUSING CLUTCH  
**SUITABLE FOR :** HONDA-CD-110  
**STD. PACK :** 4



**PART NO. :** 1650301001  
**APPLICATION :** PLATE CLUTCH ASSEMBLY  
**SUITABLE FOR :** HONDA-CD-110  
**STD. PACK :** 4



**PART NO. :** 1650101401  
**APPLICATION :** CLUTCH ASSEMBLY  
**SUITABLE FOR :** HONDA-CD-110  
**STD. PACK :** 4



**PART NO. :** 165FW00475  
**APPLICATION :** HOUSING CLUTCH - HONDA - SHINE  
**SUITABLE FOR :** HONDA-SHINE  
**STD. PACK :** 15

# CLUTCH - 2WHEELER

TVS MOTORS



**PART NO. :** 162FC00729  
**APPLICATION :** FRICTION CLUTCH - (SET OF 5)  
**SUITABLE FOR :** TVS-AX 100, SAMURAI  
**STD. PACK :** 260



**PART NO. :** 165FC01429  
**APPLICATION :** FRICTION CLUTCH (SET OF 4)  
**SUITABLE FOR :** TVS-VICTOR  
**STD. PACK :** 208

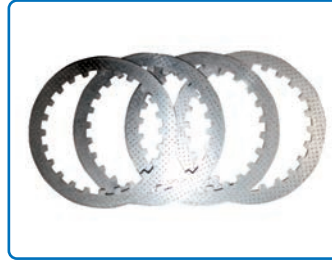

**PART NO. :** 165JT00475  
**APPLICATION :** PLATE CLUTCH SET (SET OF 4)  
**SUITABLE FOR :** TVS-APACHE  
**STD. PACK :** 30



**PART NO. :** 165FC01875  
**APPLICATION :** FRICTION CLUTCH SET - (SET OF 5)  
**SUITABLE FOR :** TVS-APACHE  
**STD. PACK :** 52



**PART NO. :** 520FY01302  
**APPLICATION :** HUB CLUTCH  
**SUITABLE FOR :** TVS-STAR, STAR CITY/SPORTS  
**STD. PACK :** 30



**PART NO. :** 520FY01402  
**APPLICATION :** HUB CLUTCH  
**SUITABLE FOR :** TVS-VICTOR, GLX  
**STD. PACK :** 30



**PART NO. :** 520FY01502  
**APPLICATION :** HUB CLUTCH  
**SUITABLE FOR :** TVS APACHE 150/RTR 160/RTR 180  
**STD. PACK :** 30



**PART NO. :** 520PP01502  
**APPLICATION :** WHEEL CLUTCH  
**SUITABLE FOR :** TVS-APACHE, STAR, STAR CITY/SPORTS, VICTOR/VICTOR GLX  
**STD. PACK :** 30



**PART NO. :** 520FW01902  
**APPLICATION :** HOUSING CLUTCH  
**SUITABLE FOR :** TVS-STAR, STAR CITY/SPORTS  
**STD. PACK :** 15



**PART NO. :** 520FW02002  
**APPLICATION :** HOUSING CLUTCH  
**SUITABLE FOR :** TVS-VICTOR, GLX, GX  
**STD. PACK :** 15

# CLUTCH - 2WHEELER

## PAPER FRICTION CLUTCH



**ENDURANCE**  
Complete Solutions



**PART NO. :** 167FC00575  
**APPLICATION :** PAPER FRICTION CLUTCH SET - (SET OF 5)  
**SUITABLE FOR :** BAJAJ PULSAR 150(UG4)  
**STD. PACK :** 22



**PART NO. :** 169FC01975  
**APPLICATION :** PAPER FRICTION CLUTCH SET - (SET OF 5)  
**SUITABLE FOR :** BAJAJ PULSAR (BSIII) UPG-4  
**STD. PACK :** 22

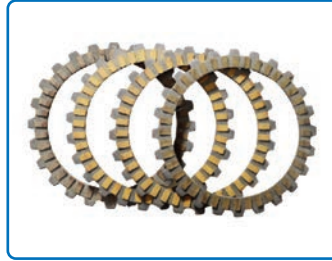

**PART NO. :** 16BFC00775  
**APPLICATION :** PAPER FRICTION CLUTCH (SET OF 4)  
**SUITABLE FOR :** YAMAHA-FZ  
**STD. PACK :** 22



**PART NO. :** 16BFC00375  
**APPLICATION :** PAPER FRICTION SET (SET OF 5)  
**SUITABLE FOR :** BAJAJ PULSAR UG-3  
**STD. PACK :** 22

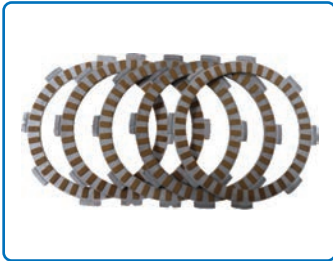

**PART NO. :** 165FC04975  
**APPLICATION :** PAPER FRICTION CLUTCH - (SET OF 5)  
**SUITABLE FOR :** BAJAJ VIKRANT 15  
**STD. PACK :** 22



**PART NO. :** 165FC03429  
**APPLICATION :** FRICTION PLATE (SET OF 4)  
**SUITABLE FOR :** HONDA-CD-110  
**STD. PACK :** 22

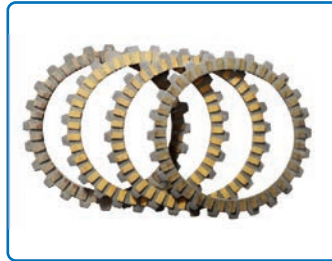

**PART NO. :** 165FC04575  
**APPLICATION :** PAPER FRICTION CLUTCH SET - HONDA - DREAM YUGA, TWISTER (SET OF 4)  
**SUITABLE FOR :** HONDA-DREAM YUGA, TWISTERB  
**STD. PACK :** 22



**PART NO. :** 165FC03429  
**APPLICATION :** PAPER FRICTION CLUTCH SET (SET OF 4)  
**SUITABLE FOR :** HONDA-SHINE  
**STD. PACK :** 22



**PART NO. :** 165FC04475  
**APPLICATION :** PAPER FRICTION CLUTCH SET - HONDA - UNICORN (SET OF 5)  
**SUITABLE FOR :** HONDA-UNICORN  
**STD. PACK :** 22



**PART NO. :** 167FC00875  
**APPLICATION :** PAPER FRICTION CLUTCH SET- (SET OF 5)  
**SUITABLE FOR :** SUZUKI-GIXXR  
**STD. PACK :** 22

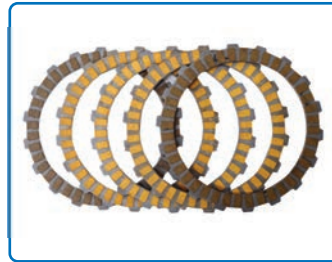

**PART NO. :** 165FC04175  
**APPLICATION :** PAPER FRICTION CLUTCH SET - (SET OF 5)  
**SUITABLE FOR :** HERO-GLAMOUR  
**STD. PACK :** 22

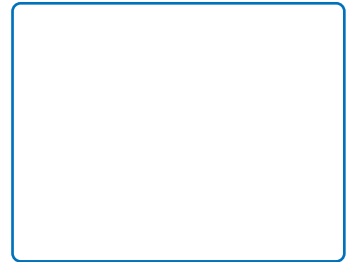

**PART NO. :** 165FC04980  
**APPLICATION :** PAPER FRICTION CLUTCH SET - (SET OF 4)  
**SUITABLE FOR :** BAJAJ DISCOVER 125  
**STD. PACK :** 22

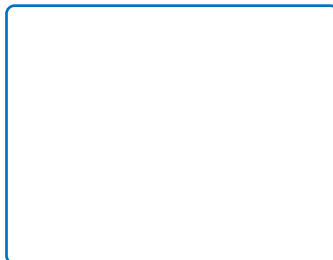

**PART NO. :** 165FC06075  
**APPLICATION :** PAPER FRICTION CLUTCH SET - (SET OF 4)  
**SUITABLE FOR :** BAJAJ PLATINA 125  
**STD. PACK :** 22

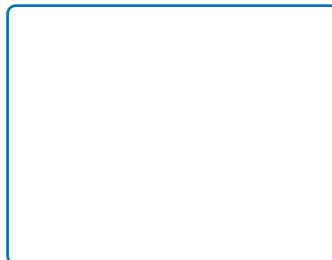

**PART NO. :** 16LFC00275  
**APPLICATION :** PAPER FRICTION CLUTCH SET - (SET OF 6)  
**SUITABLE FOR :** REML HIMALAYAN  
**STD. PACK :** 22

# 29W CVT Parts

**VARIATOR**

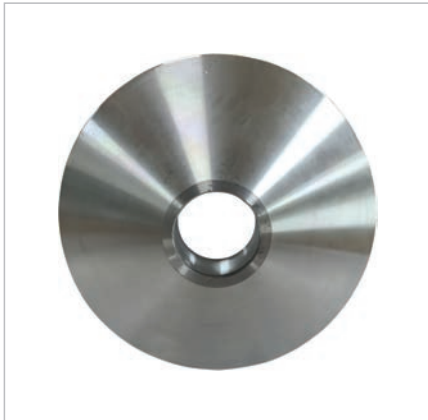

**CLUTCH SHOE**



**FACE DRIVE**



**VARIATOR ASSEMBLY**



**CLUTCH REPAIR KIT**



**ROLLER**

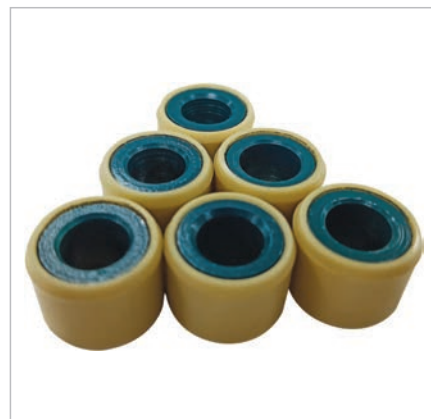

# CVT Assembly

## EXPLODED VIEW – 2W CVT

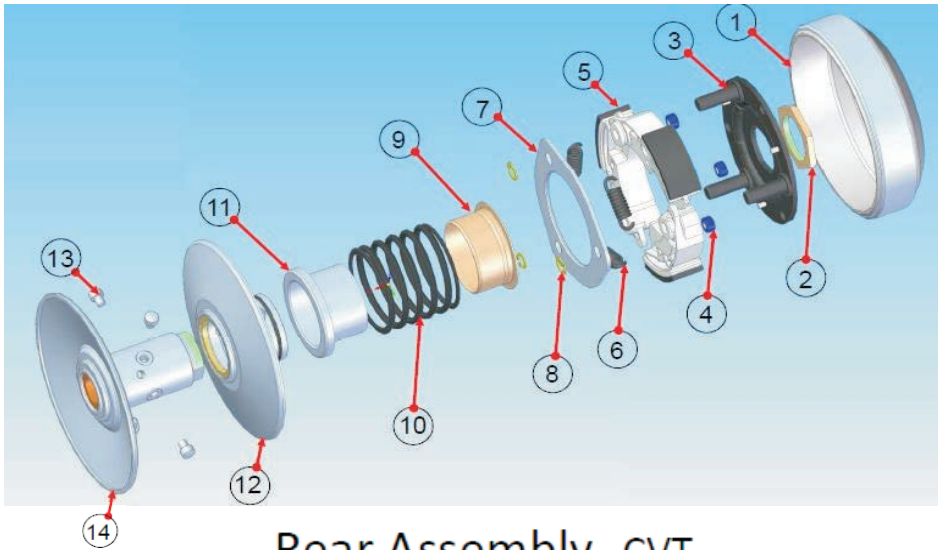

Sr.No	Part Name
1	Outer Complete Clutch
2	Nut
3	Mass Plate Assembly
4	Rubber Damper
5	Shoe Weight
6	Spring Clutch
7	Plate Clutch Side
8	Circlip
9	Spring Collar
10	Driven Face Spring
11	Seal Collar
12	Movable Driven Face Complete
13	Roller Guide Pin
14	Driven Face Assembly

Rear Assembly- CVT

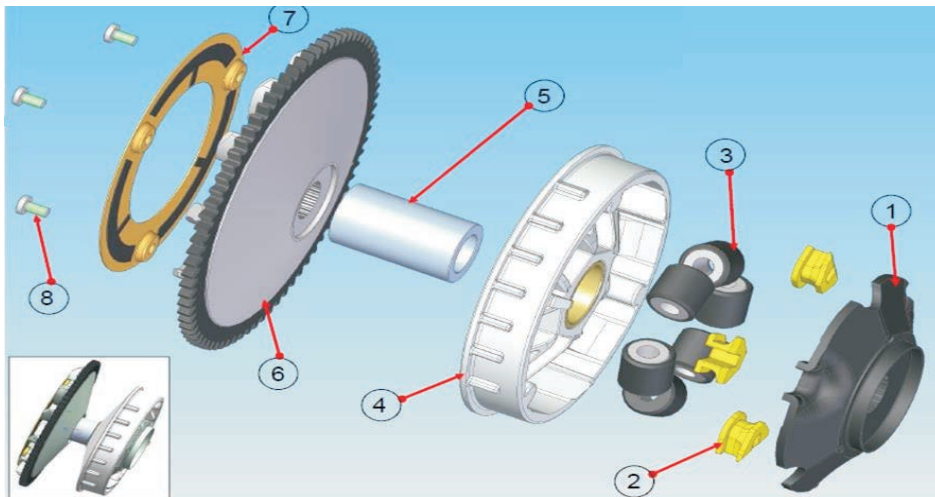

Sr.No	Part Name
1	Rollers Contrast
2	Pad
3	Roller
4	Roller Container
5	Spacer
6	Fix Drive Pulley Assembly
7	Deflector Sheet
8	Screw

Front Assembly- CVT

# CVT PARTS - 2WHEELER

## VARIATOR

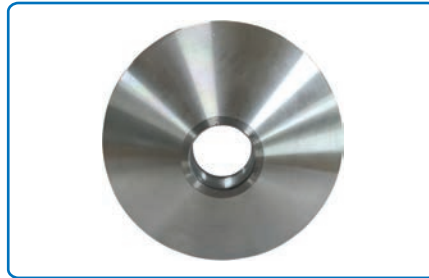

ETL PART NO.	APPLICATION	SUITABLE FOR	STD. PACK
520AM01582	VARIATOR	HONDA ACTIVA OLD/HERO PLEASURE OLD	10
520AM01583	VARIATOR	NEW /HONDA ACTIVA/DEO/HERO PLEASURE	10
520AM01584	VARIATOR	HONDA ACTIVA HET	10
520AM01586	VARIATOR	HONDA ACTIVA 125CC	10
520AM01587	VARIATOR	TVS SCOOTY PEP	10
520AM01588	VARIATOR	TVS WEGO/JUPITER	10
520AM01590	VARIATOR	MAHINDRA DURO	10
520AM01591	VARIATOR	SUZUKI ACCSS	10

## CLUTCH SHOE



ETL PART NO.	APPLICATION	SUITABLE FOR	STD. PACK
520AM01592	CLUTCH SHOE	HONDA ACTIVA OLD/HERO PLEASURE OLD	20
520AM01593	CLUTCH SHOE	HONDA ACTIVA 110/ DEO/HERO PLEASURE NEW/ MAESTRO /SUZUKI ACCESS 125	20
520AM01594	CLUTCH SHOE	HONDA ACTIVA HET/ HERO MASTRO EDGE/ PLEASURE PLUS/ SUZUKI ACCSS 125 SEP	20
520AM01595	CLUTCH SHOE	HONDA ACTIVA 3G OLD	20
520AM01596	CLUTCH SHOE	HONDA ACTIVA 125 OLD	20
520AM01597	CLUTCH SHOE	TVS SCOOTY PEP	20
520AM01598	CLUTCH SHOE	TVS WEGO/JUPITER	20
520AM01600	CLUTCH SHOE	MAHINDRA DURO	20
520AM01601	CLUTCH SHOE	TVS SUPER XL	20

# CVT PARTS - 2WHEELER

## ROLLER

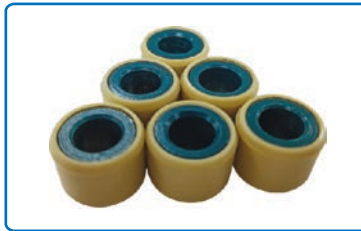

ETL PART NO.	APPLICATION	SUITABLE FOR	STD. PACK
520AM01603	ROLLER	HONDA ACTIVA OLD/HERO PLEASURE OLD	20
520AM01604	ROLLER	HONDA ACTIVA NEW/ HERO PLEASURE NEW	20
520AM01605	ROLLER	HONDA ACTIVA HET	20
520AM01606	ROLLER	HONDA ACTIVA 3G	20
520AM01607	ROLLER	HONDA ACTIVA 125 CC	20
520AM01608	ROLLER	HERO MASTRO/MASTRO EDGE 110	20
520AM01609	ROLLER	SUZUKI ACCESS	20
520AM01610	ROLLER	SUZUKI ACCSS NEW / BURGMAN	20
520AM01611	ROLLER	TVS SCOOTY PEP	20
520AM01612	ROLLER	TVS WEGO/JUPITER	20
520AM01613	ROLLER	YAMAHA REY/FASCINO	20
520AM01614	ROLLER	MAHINDRA DURO/FLYTE/RODIO	20

## FACE DRIVE



ETL PART NO.	APPLICATION	SUITABLE FOR	STD. PACK
520AM01624	FACE DRIVE	HONDA ACTIVA OLD/ HERO PLEASURE OLD	10
520AM01626	FACE DRIVE	HONDA ACTIVA HET	10
520AM01630	FACE DRIVE	TVS WEGO/JUPITER	10

## CLUTCH SHOE ASSEMBLY



ETL PART NO.	APPLICATION	SUITABLE FOR	STD. PACK
520AM02064	CLUTCH SHOE ASSEMBLY	HONDA ACTIVA / HERO PLEASURE OLD	5
520AM02065	CLUTCH SHOE ASSEMBLY	HONDA ACTIVA / HERO PLEASURE NEW/ SUZUKI ACCESS	5
520AM02066	CLUTCH SHOE ASSEMBLY	HONDA ACTIVA HET	5
520AM02067	CLUTCH SHOE ASSEMBLY	TVS SCOOTY PEP	5
520AM02068	CLUTCH SHOE ASSEMBLY	TVS WEGO/JUPITER	5

# CVT PARTS - 2WHEELER

## VARIATOR ASSEMBLY

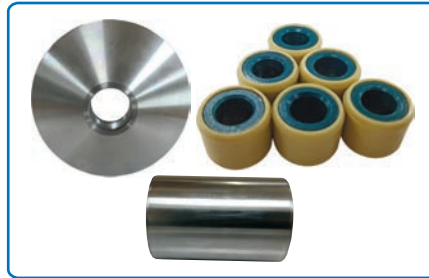

ETL PART NO.	APPLICATION	SUITABLE FOR	STD. PACK
520AM01633	VARIATOR ASSEMBLY	HONDA ACTIVA OLD/ HERO PLEASURE OLD	5
520AM01634	VARIATOR ASSEMBLY	HONDA ACTIVA NEW/PLEASURE NEW	5
520AM01635	VARIATOR ASSEMBLY	HONDA ACTIVA HET	5
520AM01637	VARIATOR ASSEMBLY	HONDA ACTIVA 125 CC	5
520AM01638	VARIATOR ASSEMBLY	TVS SCOOTY PEP	5
520AM01639	VARIATOR ASSEMBLY	TVS WEGO/JUPITER	5
520AM01642	VARIATOR ASSEMBLY	SUZUKI ACCESS	5

## CLUTCH REPAIR KIT



ETL PART NO.	APPLICATION	SUITABLE FOR	STD. PACK
520AM01615	CLUTCH REPAIR KIT	HONDA ACTIVA OLD/ HERO PLEASURE OLD	20
520AM01616	CLUTCH REPAIR KIT	HERO PLEASURE/ HONDA ACTIVA NEW/ SUZUKI ACESS	20
520AM01617	CLUTCH REPAIR KIT	HONDA ACTIVA HET	20
520AM01618	CLUTCH REPAIR KIT	HONDA ACTIVA 3G/ HERO MAESTRO EDGE	20
520AM01620	CLUTCH REPAIR KIT	TVS SCOOTY PEP	20
520AM01621	CLUTCH REPAIR KIT	TVS WEGO/JUPITER	20
520AM01623	CLUTCH REPAIR KIT	MAHINDRA DURO	20



# Braking

## Products

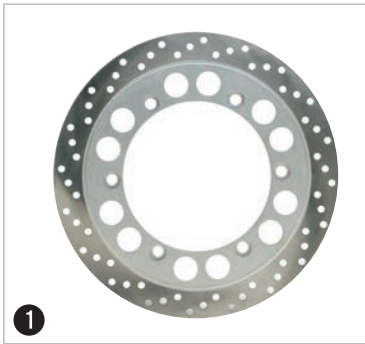

SR. NO.	DESCRIPTION
1	DISC
2	TANDEM MASTER CYLINDER (TMC) ASSLY.
3	3 WHEELER BRAKE SHOES
4	FULL DISC BRAKE ASSLY.
5	3 WHEELER DRUM BRAKE ASSLY.



# 2 & 3 WHEELER BRAKE PARTS



**ENDURANCE**  
Complete Solutions

## 2 WHEELER DISC BRAKE KIT



**PART NO. :** 2605106501  
**APPLICATION :** MASTER CYLINDER MAJOR KIT  
**SUITABLE FOR :** HERO-CBZ EXTREME, GLAMOUR, HUNK, NXG, PASSION PRO, SPLENDOR  
**STD. PACK :** 100



**PART NO. :** 2605106601  
**APPLICATION :** MASTER CYLINDER MINOR KIT  
**SUITABLE FOR :** HERO-CBZ EXTREME, GLAMOUR, HUNK, NXG, PASSION PRO, SPLENDOR  
**STD. PACK :** 100



**PART NO. :** 2605106101  
**APPLICATION :** MASTER CYLINDER MAJOR KIT  
**SUITABLE FOR :** HONDA-SHINE, UNICORN, LIVO  
**STD. PACK :** 100

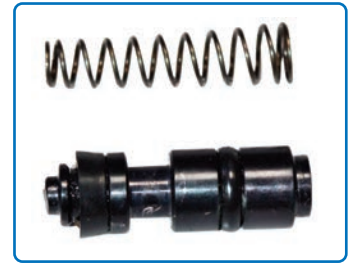

**PART NO. :** 2605106201  
**APPLICATION :** MASTER CYLINDER MINOR KIT  
**SUITABLE FOR :** HONDA-SHINE, UNICORN, LIVO  
**STD. PACK :** 100



**PART NO. :** 2605106901  
**APPLICATION :** MASTER CYLINDER MAJOR KIT  
**SUITABLE FOR :** YAMAHA-FZ / R 15  
**STD. PACK :** 100



**PART NO. :** 2605107001  
**APPLICATION :** MASTER CYLINDER MINOR KIT  
**SUITABLE FOR :** YAMAHA-FZ / R 15  
**STD. PACK :** 100



**PART NO. :** 2605100101  
**APPLICATION :** MASTER CYLINDER MAJOR KIT (ETPL)  
**SUITABLE FOR :** BAJAJ DISCOVER 125 ST / 135, PULSAR 135/150/180  
**STD. PACK :** 100



**PART NO. :** 2605100301  
**APPLICATION :** MASTER CYLINDER MAJOR KIT (KBX)  
**SUITABLE FOR :** BAJAJ DISCOVER 125 ST/135, PULSAR 135/150/180  
**STD. PACK :** 100



**PART NO. :** 2605104201  
**APPLICATION :** MASTER CYLINDER MAJOR KIT WITH GREASE  
**SUITABLE FOR :** BAJAJ DISCOVER 125 ST/135, PULSAR 135/150/180  
**STD. PACK :** 100



**PART NO. :** 2605100601  
**APPLICATION :** MASTER CYLINDER MINOR KIT  
**SUITABLE FOR :** BAJAJ-PULSAR 135/150/180  
**STD. PACK :** 100



**PART NO. :** 2605107501  
**APPLICATION :** MASTER CYLINDER MAJOR KIT  
**SUITABLE FOR :** BAJAJ-PULSAR 150 AS/150 NS / 150 ST/ 200 RS  
**STD. PACK :** 100



**PART NO. :** 2605107601  
**APPLICATION :** MASTER CYLINDER MINOR KIT  
**SUITABLE FOR :** BAJAJ-PULSAR 150 AS/150 NS / 150 ST/ 200 RS  
**STD. PACK :** 100



**PART NO. :** 2605100701  
**APPLICATION :** MASTER CYLINDER SEALS KIT  
**SUITABLE FOR :** BAJAJ DISCOVER 125 ST/135/150 ST, PULSAR 135/150/180  
**STD. PACK :** 100



**PART NO. :** 2605101801  
**APPLICATION :** OIL LEVEL WINDOW KIT  
**SUITABLE FOR :** BAJAJ DISCOVER 125 ST/135/150 ST, PULSAR 135/150/180  
**STD. PACK :** 100



**PART NO. :** 2605106701  
**APPLICATION :** CALIPER MAJOR KIT  
**SUITABLE FOR :** HERO-CBZ EXTREME, GLAMOUR, HUNK, NXG, PASSION PRO, SPLENDOR  
**STD. PACK :** 40



**PART NO. :** 2605106801  
**APPLICATION :** CALIPER MINOR KIT  
**SUITABLE FOR :** HERO-CBZ EXTREME, GLAMOUR, HUNK, NXG, PASSION PRO, SPLENDOR  
**STD. PACK :** 100

# 2 & 3 WHEELER BRAKE PARTS



**ENDURANCE**  
Complete Solutions

## 2 WHEELER DISC BRAKE KIT



**PART NO. :** 2605106301  
**APPLICATION :** CALIPER MAJOR KIT  
**SUITABLE FOR :** HONDA-SHINE, UNICORN, LIVO  
**STD. PACK :** 40



**PART NO. :** 2605106401  
**APPLICATION :** CALIPER MINOR KIT  
**SUITABLE FOR :** HONDA-SHINE, UNICORN, LIVO  
**STD. PACK :** 100



**PART NO. :** 2605100901  
**APPLICATION :** CALIPER MAJOR KIT  
**SUITABLE FOR :** BAJAJ DISCOVER 125 ST/135, PULSAR 135/150/180  
**STD. PACK :** 40



**PART NO. :** 2605104401  
**APPLICATION :** CALIPER MAJOR KIT WITH GREASE  
**SUITABLE FOR :** BAJAJ DISCOVER 125 ST/135, PULSAR 135/150 ST  
**STD. PACK :** 40



**PART NO. :** 2605100201  
**APPLICATION :** CALIPER MINOR KIT(ETPL)  
**SUITABLE FOR :** BAJAJ DISCOVER 125 ST / 135, PULSAR 135/150/180  
**STD. PACK :** 100



**PART NO. :** 2605100401  
**APPLICATION :** CALIPER MINOR KIT(KBX)  
**SUITABLE FOR :** B  
**STD. PACK :** 1



**PART NO. :** 2605104301  
**APPLICATION :** CALIPER MINOR KIT WITH GREASE  
**SUITABLE FOR :** BAJAJ DISCOVER 125 ST/135, PULSAR 135/150/180  
**STD. PACK :** 100



**PART NO. :** 2605101101  
**APPLICATION :** CALIPER MINI KIT  
**SUITABLE FOR :** BAJAJ DISCOVER 125 ST/135, PULSAR 135/150/180  
**STD. PACK :** 125



**PART NO. :** 2605104801  
**APPLICATION :** CALIPER MAJOR KIT WITH GREASE  
**SUITABLE FOR :** BAJAJ PULSAR 150 AS / 150 NS / 150 ST/ 200 RS  
**STD. PACK :** 100



**PART NO. :** 2605104901  
**APPLICATION :** CALIPER MINOR KIT WITH GREASE  
**SUITABLE FOR :** BAJAJ PULSAR 150 AS / 150 NS / 150 ST/ 200 RS  
**STD. PACK :** 100

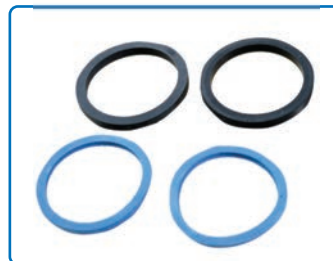

**PART NO. :** 2605101201  
**APPLICATION :** CALIPER SEALS KIT  
**SUITABLE FOR :** BAJAJ DISCOVER 125 ST/135, PULSAR 135/150/180  
**STD. PACK :** 100



**PART NO. :** 2605101301  
**APPLICATION :** CALIPER PISTON SET  
**SUITABLE FOR :** BAJAJ DISCOVER 125 ST/135, PULSAR 150/180  
**STD. PACK :** 40

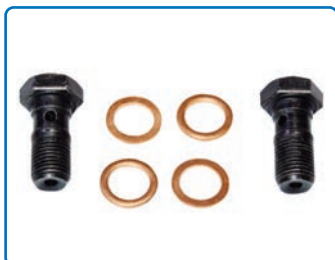

**PART NO. :** 2605101501  
**APPLICATION :** BANJO KIT  
**SUITABLE FOR :** BAJAJ PULSAR 150/180  
**STD. PACK :** 100



**PART NO. :** 2605101701  
**APPLICATION :** DUST BOOT KIT  
**SUITABLE FOR :** BAJAJ PULSAR 150/180  
**STD. PACK :** 40



**PART NO. :** 2605101401  
**APPLICATION :** ANCHOR PIN KIT  
**SUITABLE FOR :** BAJAJ PULSAR 150/180  
**STD. PACK :** 40



**PART NO. :** 2605109101  
**APPLICATION :** MINOR KIT MASTER CYLINDER  
**SUITABLE FOR :** BAJAJ AVANGER -150  
**STD. PACK :** 100

# 2 & 3 WHEELER BRAKE PARTS



**ENDURANCE**  
Complete Solutions

## 2 WHEELER DISC BRAKE KIT



**PART NO. :** 2605108801  
**APPLICATION :** SEAL KIT  
MASTER CYLINDER  
**SUITABLE FOR :** BAJAJ  
AVANGER -150  
**STD. PACK :** 100



**PART NO. :** 2605107801  
**APPLICATION :** MINI KIT  
CALIPER WITH GREASE  
**SUITABLE FOR :** BAJAJ  
PULSAR 150 NS  
**STD. PACK :** 100



**PART NO. :** 2605109001  
**APPLICATION :** MINI KIT  
CALIPER WITH GREASE  
**SUITABLE FOR :** BAJAJ  
AVANGER -150  
**STD. PACK :** 100



**PART NO. :** 2605113001  
**APPLICATION :** MAJOR KIT  
REAR CALIPER  
**SUITABLE FOR :** BAJAJ  
PULSAR 180 / 200NS  
**STD. PACK :** 40



**PART NO. :** 2605113101  
**APPLICATION :** MINOR KIT  
REAR CALIPER  
**SUITABLE FOR :** BAJAJ  
PULSAR 180 / 200NS  
**STD. PACK :** 40



**PART NO. :** 2605112501  
**APPLICATION :** MAJOR KIT  
REAR MASTER CYLINDER  
**SUITABLE FOR :** BAJAJ  
PULSAR 180 / 200NS  
**STD. PACK :** 40



**PART NO. :** 2605112601  
**APPLICATION :** MINOR KIT  
REAR MASTER CYLINDER  
**SUITABLE FOR :** BAJAJ  
PULSAR 180 / 200NS  
**STD. PACK :** 40



**PART NO. :** 2605108501  
**APPLICATION :** MAJOR KIT  
MASTER CYLINDER  
**SUITABLE FOR :** AVANGER  
150 STREET  
**STD. PACK :** 100



**PART NO. :** 2605108501  
**APPLICATION :** MAJOR KIT  
MASTER CYLINDER  
**SUITABLE FOR :** AVANGER  
150 STREET  
**STD. PACK :** 100

# 2 & 3 WHEELER BRAKE PARTS



**ENDURANCE**  
Complete Solutions

## 2 WHEELER DISC BRAKE SPARES



**PART NO. :** B201011000  
**APPLICATION :** DISC BRAKE ASSY - (W/O DISC)  
**SUITABLE FOR :** BAJAJ VIKRANT  
**STD. PACK :** 2



**PART NO. :** 2610101101  
**APPLICATION :** DISC BRAKE ASSEMBLY (WITHOUT DISC)  
**SUITABLE FOR :** BAJAJ PULSAR 135  
**STD. PACK :** 2



**PART NO. :** B201001000  
**APPLICATION :** DISC BRAKE ASSEMBLY (WITHOUT DISC)  
**SUITABLE FOR :** BAJAJ PULSAR 150 AS/150 NS/150 ST/200 RS  
**STD. PACK :** 2



**PART NO. :** 2610100501  
**APPLICATION :** DISC BRAKE ASSEMBLY (WITHOUT DISC)  
**SUITABLE FOR :** BAJAJ DISCOVER 125  
**STD. PACK :** 2



**PART NO. :** 2610101201  
**APPLICATION :** DISC BRAKE ASSEMBLY (WITHOUT DISC)  
**SUITABLE FOR :** BAJAJ DISCOVER 150  
**STD. PACK :** 2



**PART NO. :** 2610100101  
**APPLICATION :** DISC BRAKE ASSEMBLY (WITHOUT DISC)  
**SUITABLE FOR :** BAJAJ PULSAR 135/150/180  
**STD. PACK :** 2



**PART NO. :** B201028000  
**APPLICATION :** REAR BRAKE ASSY  
**SUITABLE FOR :** BAJAJ PULSAR 200 NS / PULSAR 180  
**STD. PACK :** 1



**PART NO. :** 2660100101  
**APPLICATION :** DISC BRAKE SYSTEM WITHOUT DISC  
**SUITABLE FOR :** ROYAL ENFIELD CLASSIC, ELECTRA  
**STD. PACK :** 2



**PART NO. :** B201012000  
**APPLICATION :** DISC BRAKE KIT  
**SUITABLE FOR :** BAJAJ AVENGER 150  
**STD. PACK :** 2



**PART NO. :** B201002000  
**APPLICATION :** DISC BRAKE KIT  
**SUITABLE FOR :** BAJAJ PULSAR 180 BS3  
**STD. PACK :** 2



**PART NO. :** B201029000  
**APPLICATION :** DISC BRAKE KIT  
**SUITABLE FOR :** BAJAJ PULSAR 180 BS4  
**STD. PACK :** 2



**APPLICATION :** DISC BRAKE ASSY  
**SUITABLE FOR :** TVS APACHE  
**STD. PACK :** 2



**PART NO. :** B202019000  
**APPLICATION :** REAR MASTER CYLINDER ASSY  
**SUITABLE FOR :** BAJAJ PULSAR 180 / 200NS  
**STD. PACK :** 5



**PART NO. :** B201019000  
**APPLICATION :** REAR MASTER CYLINDER ASSEMBLY  
**SUITABLE FOR :** BAJAJ PULSAR 200 NS / PULSAR 180  
**STD. PACK :** 5

# 2 & 3 WHEELER BRAKE PARTS



**ENDURANCE**  
Complete Solutions

## 2 WHEELER DISC BRAKE SPARES



**PART NO. :** B203027000  
**APPLICATION :** CALIPER ASSY  
**SUITABLE FOR :** BAJAJ  
PULSAR 200 NS / PULSAR 180  
**STD. PACK :** 4



**PART NO. :** 2610300101  
**APPLICATION :** CALIPER ASSY  
**SUITABLE FOR :** BAJAJ  
DISCOVER 150,  
PULSAR 135/150/180  
**STD. PACK :** 6



**PART NO. :** 2610300901  
**APPLICATION :** CALIPER ASSY  
BLACK  
**SUITABLE FOR :** BAJAJ  
DISCOVER 150, PULSAR 135  
**STD. PACK :** 6



**PART NO. :** 2610300301  
**APPLICATION :** CALIPER ASSY  
SILVER  
**SUITABLE FOR :** BAJAJ-DISCOVER  
125 / 125 ST / 135, XCD 135  
**STD. PACK :** 6



**PART NO. :** 2610300401  
**APPLICATION :** CALIPER ASSY  
SILVER  
**SUITABLE FOR :** BAJAJ  
PULSAR 150/180  
**STD. PACK :** 6



**PART NO. :** B203004000  
**APPLICATION :** CALIPER ASSY  
**SUITABLE FOR :** BAJAJ  
PULSAR 150 AS/150 NS/  
150 ST/ 200 RS  
**STD. PACK :** 6



**PART NO. :** 2610301201  
**APPLICATION :** CALIPER ASSLY  
**SUITABLE FOR :** BAJAJ  
VIKRANT  
**STD. PACK :** 6



**PART NO. :** B203012000  
**APPLICATION :** CALIPER ASSLY  
**SUITABLE FOR :** AVANGER  
150 STREET  
**STD. PACK :** 6



**PART NO. :** B203013000  
**APPLICATION :** CALIPER ASSY  
**SUITABLE FOR :** HERO-GLAMOUR,  
HONDA - SHINE  
**STD. PACK :** 6



**PART NO. :** 2660300101  
**APPLICATION :** CALIPER  
ASSEMBLY  
**SUITABLE FOR :** ROYAL ENFIELD  
CLASSIC, ELECTRA  
**STD. PACK :** 6



**PART NO. :** 260BP00475  
**APPLICATION :** BRAKE LEVER  
**SUITABLE FOR :** BAJAJ  
DISCOVER 125 ST/135/150 ST,  
PULSAR 135/150/180, XCD 135  
**STD. PACK :** 50



**PART NO. :** 260BP01001  
**APPLICATION :** BRAKE LEVER UPG  
**SUITABLE FOR :** BAJAJ  
DISCOVER 125 ST/135/150,  
PULSAR 135/150/180, XCD 135  
**STD. PACK :** 40



**PART NO. :** B202005000  
**APPLICATION :** MASTER  
CYLINDER ASSY  
**SUITABLE FOR :** BAJAJ  
PULSAR 150 AS/150 NS/  
150 ST/ 200 RS  
**STD. PACK :** 5



**PART NO. :** 2660200201  
**APPLICATION :** MASTER  
CYLINDER ASSEMBLY  
**SUITABLE FOR :** ROYAL ENFIELD  
CLASSIC, ELECTRA  
**STD. PACK :** 4



**PART NO. :** 2610200101  
**APPLICATION :** MASTER  
CYLINDER ASSY  
**SUITABLE FOR :** BAJAJ  
DISCOVER 125 ST/135,  
PULSAR 135/150/180  
**STD. PACK :** 5



**PART NO. :** B202006000  
**APPLICATION :** MASTER  
CYLINDER ASSY  
**SUITABLE FOR :** PULSAR  
DTSI 150UG / 180 UG /  
AVANGER 150 /220  
**STD. PACK :** 5

# 2 & 3 WHEELER BRAKE PARTS



**ENDURANCE**  
Complete Solutions

## 2 WHEELER DISC BRAKE SPARES



**PART NO. :** 2620500631  
**APPLICATION :** DISC  
**SUITABLE FOR :** BAJAJ  
DISCOVER 125  
**STD. PACK :** 2

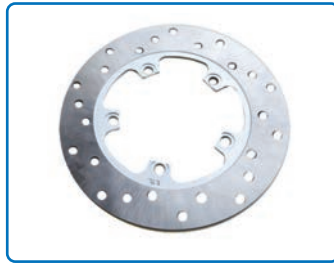

**PART NO. :** 2620500131  
**APPLICATION :** DISC  
**SUITABLE FOR :** BAJAJ  
XCD 135/ DISCOVER 135  
**STD. PACK :** 5



**PART NO. :** 2630500731  
**APPLICATION :** DISC  
**SUITABLE FOR :** BAJAJ  
DISCOVER 150  
**STD. PACK :** 2

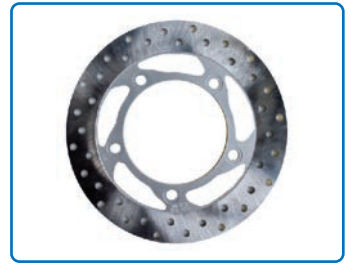

**PART NO. :** 2630500431  
**APPLICATION :** DISC  
**SUITABLE FOR :** BAJAJ  
PULSAR 135  
**STD. PACK :** 5



**PART NO. :** 2630500531  
**APPLICATION :** DISC  
**SUITABLE FOR :** BAJAJ  
PULSAR 150/180 UPG  
**STD. PACK :** 5



**PART NO. :** B205001280  
**APPLICATION :** DISC  
**SUITABLE FOR :** BAJAJ  
PULSAR 150 AS/150 NS/150 ST/  
200 RS  
**STD. PACK :** 2



**PART NO. :** B205035280  
**APPLICATION :** DISC- BLACK  
**SUITABLE FOR :** BAJAJ  
PULSAR 135 BLACK  
**STD. PACK :** 5



**PART NO. :** B205010280  
**APPLICATION :** DISC REAR  
**SUITABLE FOR :** BAJAJ AVANGER  
150 /180/220/ DISCOVER 135/  
PULSAR DTSI-150 UPG/220 REAR  
**STD. PACK :** 2



**PART NO. :** B205049280  
**APPLICATION :** DISC - SILVER  
**SUITABLE FOR :** BAJAJ  
PULSAR 200 NS  
**STD. PACK :** 2



**PART NO. :** B205034280  
**APPLICATION :** DISC- BLACK  
**SUITABLE FOR :** BAJAJ PULSAR  
DTSI 150 UPG BLACK  
**STD. PACK :** 5



**PART NO. :** B205041280  
**APPLICATION :** DISC REAR  
**SUITABLE FOR :** BAJAJ  
PULSAR 200 NS  
**STD. PACK :** 2



**PART NO. :** B205013280  
**APPLICATION :** DISC  
**SUITABLE FOR :** BAJAJ  
AVENGER 150  
**STD. PACK :** 2



**PART NO. :** B205039280  
**APPLICATION :** DISC REAR  
**SUITABLE FOR :** BAJAJ  
PULSAR 180  
**STD. PACK :** 2



**PART NO. :** B205003280  
**APPLICATION :** DISC  
**SUITABLE FOR :** BAJAJ  
PULSAR 180/220 BS3  
**STD. PACK :** 2



**PART NO. :** B205033280  
**APPLICATION :** DISC  
**SUITABLE FOR :** BAJAJ  
PULSAR 180/220 BS4  
**STD. PACK :** 2



**PART NO. :** B205042280  
**APPLICATION :** DISC  
**SUITABLE FOR :** BAJAJ VIKRANT  
**STD. PACK :** 5

# 2 & 3 WHEELER BRAKE PARTS



**ENDURANCE**  
Complete Solutions

## 2 WHEELER DISC BRAKE SPARES

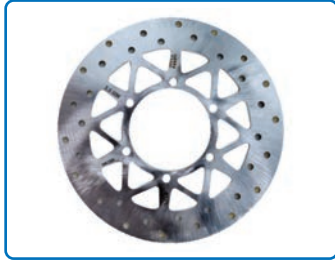

**PART NO. :** 2630500231  
**APPLICATION :** DISC  
**SUITABLE FOR :** YAMAHA  
GLADIATOR  
**STD. PACK :** 2



**PART NO. :** 2640500231  
**APPLICATION :** DISC - (FRONT)  
**SUITABLE FOR :** YAMAHA-FZ,  
R 15  
**STD. PACK :** 2



**PART NO. :** 2620500431  
**APPLICATION :** DISC - REAR  
**SUITABLE FOR :** YAMAHA-R15  
**STD. PACK :** 2



**PART NO. :** 2620500531  
**APPLICATION :** DISC - REAR  
**SUITABLE FOR :** YAMAHA-R15  
**STD. PACK :** 2



**PART NO. :** B205037280  
**APPLICATION :** DISC - FRONT  
**SUITABLE FOR :** HONDA  
**STD. PACK :** 2



**PART NO. :** 2650500131  
**APPLICATION :** BRAKE DISC  
**SUITABLE FOR :** ROYAL ENFIELD  
CLASSIC, ELECTRA  
**STD. PACK :** 2



**PART NO. :** B2GQ001240  
**APPLICATION :** MASTER  
CYLINDER ASSY  
**SUITABLE FOR :** DISCOVER-135/  
PULSAR 150 DTSI 150/180/200/220  
**STD. PACK :** 6



**PART NO. :** 260KN00107  
**APPLICATION :** RESRVR CAP  
**SUITABLE FOR :** BAJAJ PULSAR  
DTSI 150UG / 180 UG /  
AVANGER 150 /220  
**STD. PACK :** 100



**PART NO. :** 410BT01175  
**APPLICATION :** BRAKE HOSE  
PIPE  
**SUITABLE FOR :** BAJAJ  
PULSAR 135  
**STD. PACK :** 10



**PART NO. :** 410BT01875  
**APPLICATION :** BRAKE HOSE  
PIPE  
**SUITABLE FOR :** BAJAJ  
PULSAR 150/180 HF  
**STD. PACK :** 10



**PART NO. :** 410BT01775  
**APPLICATION :** BRAKE HOSE PIPE  
**SUITABLE FOR :** BAJAJ  
PULSAR 150 AS/150 NS /  
150 ST/ 200 RS  
**STD. PACK :** 10



**PART NO. :** 410BT00375  
**APPLICATION :** BRAKE HOSE  
PIPE  
**SUITABLE FOR :** BAJAJ  
DISCOVER 125 OLD  
**STD. PACK :** 10



**PART NO. :** 410BT04375  
**APPLICATION :** REAR BRAKE  
HOSE PIPE  
**SUITABLE FOR :** BAJAJ  
PULSAR 200NS/PULSAR180  
**STD. PACK :** 10



**PART NO. :** 410BT00475  
**APPLICATION :** BRAKE HOSE  
PIPE  
**SUITABLE FOR :** BAJAJ  
DISCOVER 125  
**STD. PACK :** 10



**PART NO. :** 410BT00675  
**APPLICATION :** BRAKE HOSE  
**SUITABLE FOR :** ROYAL ENFIELD  
CLASSIC, ELECTRA  
**STD. PACK :** 27



**PART NO. :** 410BT00175  
**APPLICATION :** BRAKE HOSE  
**SUITABLE FOR :** BAJAJ  
DISCOVER 150,  
PULSAR 135/150/180  
**STD. PACK :** 27



# 2 & 3 WHEELER BRAKE PARTS



**ENDURANCE**  
Complete Solutions

## 2 WHEELER DISC BRAKE SPARES

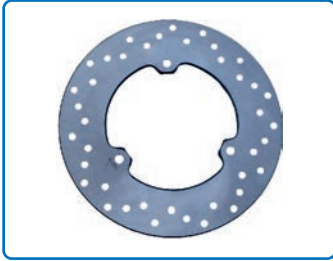

**PART NO. :** B205014280  
**APPLICATION :** DISC  
**SUITABLE FOR :** YAMAHA FZ 150,  
250 MTN, R15BS6  
**STD. PACK :** 2

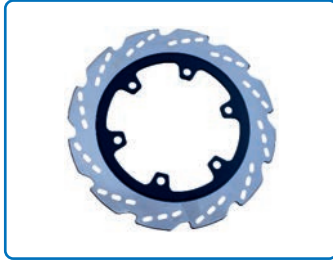

**PART NO. :** B205089280  
**APPLICATION :** DISC  
**SUITABLE FOR :** TVS APACHE  
160/180  
**STD. PACK :** 5

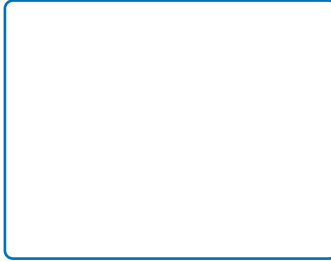

**PART NO. :** B205143280  
**APPLICATION :** DISC  
**SUITABLE FOR :** TVS JUPITER  
220 DIA  
**STD. PACK :** 2

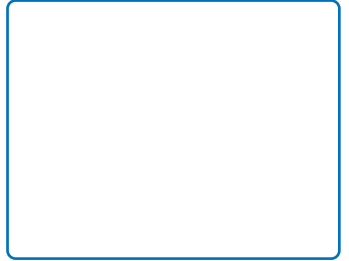

**PART NO. :** B205127280  
**APPLICATION :** DISC  
**SUITABLE FOR :** TVS NTRQ  
220 DIA  
**STD. PACK :** 2



**PART NO. :** B205125280  
**APPLICATION :** DISC  
**SUITABLE FOR :** TVS APACHE  
200MM REAR  
**STD. PACK :** 2



**PART NO. :** B205015280  
**APPLICATION :** DISC  
**SUITABLE FOR :** YAMAHA 282MM  
**STD. PACK :** 5



**PART NO. :** B205011280  
**APPLICATION :** DISC  
**SUITABLE FOR :** BAJAJ PULSAR  
200 NS 280 MM  
**STD. PACK :** 5



**PART NO. :** B205028280  
**APPLICATION :** DISC  
**SUITABLE FOR :** BAJAJ PULSAR  
200 NS REAR 230 MM  
**STD. PACK :** 5

# 2 & 3 WHEELER BRAKE PARTS



**ENDURANCE**  
Complete Solutions

## 2 WHEELER DISC PAD - SUPER SERIES



**PART NO. :** 2605108301  
**APPLICATION :** DISC PAD  
**SUITABLE FOR :** TVS-APACHE  
**STD. PACK :** 50



**PART NO. :** 2605102501  
**APPLICATION :** DISC PAD SET  
**SUITABLE FOR :** BAJAJ  
DISCOVER 125/135, XCD 135  
**STD. PACK :** 50



**PART NO. :** 2605100501  
**APPLICATION :** DISC PAD SET  
**SUITABLE FOR :** BAJAJ  
PULSAR 150/180  
**STD. PACK :** 50



**PART NO. :** 2605111001  
**APPLICATION :** REAR DISC PAD  
**SUITABLE FOR :** BAJAJ  
PULSAR 180 / 200NS  
**STD. PACK :** 50



**PART NO. :** 2605107301  
**APPLICATION :** DISC PAD SET  
**SUITABLE FOR :** HONDA-SHINE  
UNICORN  
**STD. PACK :** 50



**PART NO. :** 2605108201  
**APPLICATION :** DISC PAD  
**SUITABLE FOR :** SUZUKI  
GIXXER  
**STD. PACK :** 50



**PART NO. :** 2605105901  
**APPLICATION :** DISC PAD SET  
**SUITABLE FOR :** YAMAHA-FZ /  
R 15  
**STD. PACK :** 50



**PART NO. :** 2605107401  
**APPLICATION :** DISC PAD SET  
**SUITABLE FOR :** HERO  
PASSION  
**STD. PACK :** 50



**PART NO. :** 2605114601  
**APPLICATION :** DISC PAD  
**SUITABLE FOR :** REML CLASSIC 50 /  
ELECTRA REAR  
**STD. PACK :** 50



**PART NO. :** 2605102301  
**APPLICATION :** DISC PAD  
**SUITABLE FOR :** REML CLASSIC 350 /  
ELECTRA FRONT  
**STD. PACK :** 30

## 2 WHEELER DISC PAD - REGULAR SERIES



**PART NO. :** 520AM02083  
**APPLICATION :** DISC PAD  
**SUITABLE FOR :** BAJAJ PULSAR  
**STD. PACK :** 50



**PART NO. :** 520AM02084  
**APPLICATION :** DISC PAD  
**SUITABLE FOR :** BJ PLSR 220CC  
(N/M) (REAR) REG  
**STD. PACK :** 50



**PART NO. :** 520AM02076  
**APPLICATION :** DISC PAD  
**SUITABLE FOR :** HERO CBZ  
**STD. PACK :** 30



**PART NO. :** 520AM02078  
**APPLICATION :** DISC PAD  
**SUITABLE FOR :** HERO HUNK/  
KARIZMA/ZMR/CBZ XTRM REAR  
**STD. PACK :** 30

# 2 & 3 WHEELER BRAKE PARTS



**ENDURANCE**  
Complete Solutions

## 2 WHEELER DISC PAD - SUPER SERIES



**PART NO. :** 520AM02077  
**APPLICATION :** DISC PAD  
**SUITABLE FOR :** HERO PASSION PLUS  
**STD. PACK :** 30



**PART NO. :** 520AM02071  
**APPLICATION :** DISC PAD  
**SUITABLE FOR :** HONDA TWISTER /SHINE NEW/UNICORN/TRIGGER (SINGLE PLUNGER)  
**STD. PACK :** 30



**PART NO. :** 520AM02072  
**APPLICATION :** DISC PAD  
**SUITABLE FOR :** HONDA UNICORN 160/DAZZLER SZK GXR REAR  
**STD. PACK :** 30



**PART NO. :** 520AM02075  
**APPLICATION :** DISC PAD  
**SUITABLE FOR :** HONDA CB 125 SHINE  
**STD. PACK :** 30



**PART NO. :** 520AM02087  
**APPLICATION :** DISC PAD  
**SUITABLE FOR :** SUZUKI GIXXER PLUS  
**STD. PACK :** 30



**PART NO. :** 520AM02088  
**APPLICATION :** DISC PAD  
**SUITABLE FOR :** SUZUKI GS150R  
**STD. PACK :** 30



**PART NO. :** 520AM02079  
**APPLICATION :** DISC PAD  
**SUITABLE FOR :** TVS APACHE RTR REAR  
**STD. PACK :** 30

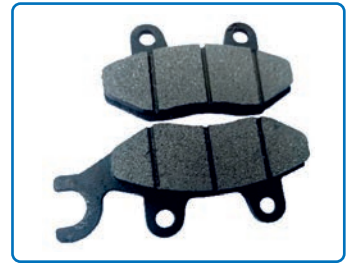

**PART NO. :** 520AM02082  
**APPLICATION :** DISC PAD  
**SUITABLE FOR :** TVS APACHE RTR  
**STD. PACK :** 30



**PART NO. :** 520AM02080  
**APPLICATION :** DISC PAD  
**SUITABLE FOR :** TVS JUPITER  
**STD. PACK :** 30



**PART NO. :** 520AM02081  
**APPLICATION :** DISC PAD  
**SUITABLE FOR :** TVS NTORQ  
**STD. PACK :** 30



**PART NO. :** 520AM02090  
**APPLICATION :** DISC PAD  
**SUITABLE FOR :** YAMAHA R-15 REAR  
**STD. PACK :** 30



**PART NO. :** 520AM02089  
**APPLICATION :** DISC PAD  
**SUITABLE FOR :** YAMAHA FZ  
**STD. PACK :** 30



**PART NO. :** 520AM02086  
**APPLICATION :** DISC PAD  
**SUITABLE FOR :** REML CLASSIC 350/ELECTRA REAR  
**STD. PACK :** 30



**PART NO. :** 520AM02085  
**APPLICATION :** DISC PAD  
**SUITABLE FOR :** REML CLASSIC 350/ELECTRA NEW MODEL  
**STD. PACK :** 30

# 2 & 3 WHEELER BRAKE PARTS



**ENDURANCE**  
Complete Solutions

## 2 WHEELER BRAKE SHOE



ETL PART NO.	APPLICATION	SUITABLE FOR	STD. PACK
520AM01643	BRAKE SHOE	RR - HERO SPLENDOR/SPLENDOR +/- PASSION/ DAWN	20
520AM01644	BRAKE SHOE	FR/RR- HERO SUPER SPLENDOR/GLAMOURMR/CBZ XTRM-RR	20
520AM01651	BRAKE SHOE	FR/RR- HERO CD DLX	20
520AM01652	BRAKE SHOE	BRAKE SHOE FR- HERO CD 100	20
520AM01645	BRAKE SHOE	FR- HERO SPLENDOR/SPLENDOR +/- PASSION/ AMBITION-RR	20
520AM01646	BRAKE SHOE	FR/RR-BAJAJ KB4S/BOXER/CT100/PLATINA	20
520AM01647	BRAKE SHOE	FR/RR- BAJAJ PULSAR/KB100/DISCOVER/CROMA	20
520AM01648	BRAKE SHOE	FR/RR-BJ CALIBER CROMA/LEGEND/CHETAK 4S-FR	20
520AM01664	BRAKE SHOE	RR-BAJAJ AVANGER	20
520AM01665	BRAKE SHOE	RR-BAJAJ CHETAK 4S	20
520AM01666	BRAKE SHOE	RR-BAJAJ SUPER	20
520AM01667	BRAKE SHOE	FR-BJ SUPER	20
520AM01668	BRAKE SHOE	RR-BJ CHETAK/LML NV	20
520AM01669	BRAKE SHOE	FR-BJ CHETAK/LML NV	20
520AM01670	BRAKE SHOE	BJ M80	20
520AM01649	BRAKE SHOE	RR-UNICORN/TRIGGER/NEO/ SHINE/TWISTR	20
520AM01650	BRAKE SHOE	FR/RR OLD ACTIVA/DIO/ETERNO	20
520AM01654	BRAKE SHOE	FR/RR - TVS PEP	20
520AM01655	BRAKE SHOE	FR- TVS XL SUPER / XL 50 RR	20
520AM01656	BRAKE SHOE	FR/RR - TVS XL 100	20
520AM01657	BRAKE SHOE	RR - TVS JUPITER/WEGO	20
520AM01671	BRAKE SHOE	RR-TVS STAR CITY/SCOOTY FR/SPORT RR	20
520AM01672	BRAKE SHOE	FR/RR-TV FLAME/CENTRA/VICTOR	20
520AM01673	BRAKE SHOE	RR-TVS APACHE /APACHE HET/FIERO/SCOOTY /ZEST	20
520AM01674	BRAKE SHOE	FR- TVS FIERO/SCOOTY	20
520AM01653	BRAKE SHOE	FR/RR- SUZUKI ACCESS	20
520AM01675	BRAKE SHOE	RR - SUZUKI HAYATE	20
520AM01676	BRAKE SHOE	FR - SUZUKI HAYATE	20
520AM01659	BRAKE SHOE	FR/RR- REML BONDED	20
520AM01660	BRAKE SHOE	FR/RR- REML 500	20
520AM01661	BRAKE SHOE	FR/RR- YAMAHA RX100/ RX135/YBX/CRUX/LIBERO	20
520AM01662	BRAKE SHOE	RR- YAMAHA FAZER (FR & RR)/FZ/REY	20
520AM01663	BRAKE SHOE	FR/RR-YAMAHA CYGNUS REY ZR	20
520AM01677	BRAKE SHOE	FR/RR- KINETIC HONDA	20
520AM01678	BRAKE SHOE	FR/RR- LML FREEDOM/ADERNO/ENERGY	20
520AM01679	BRAKE SHOE	FR/RR- MM CENTRO/DRO/FLYT	20

# 2 & 3 WHEELER BRAKE PARTS



**ENDURANCE**  
Complete Solutions

## 3 WHEELER BRAKE KIT



**PART NO. :** 2805104301  
**APPLICATION :** MAJOR KIT FOR WHEEL CYLINDER  
**SUITABLE FOR :** PIAGGIO-APE  
**STD. PACK :** 40



**PART NO. :** 2805104401  
**APPLICATION :** MINOR KIT FOR WHEEL CYLINDER  
**SUITABLE FOR :** PIAGGIO-APE  
**STD. PACK :** 40



**PART NO. :** 2805104501  
**APPLICATION :** MAJOR KIT FOR WHEEL CYLINDER  
**SUITABLE FOR :** PIAGGIO-APE  
**STD. PACK :** 40



**PART NO. :** 2805104601  
**APPLICATION :** MINOR KIT FOR WHEEL CYLINDER  
**SUITABLE FOR :** PIAGGIO-APE  
**STD. PACK :** 40



**PART NO. :** 2805103901  
**APPLICATION :** MAJOR KIT FOR WHEEL CYLINDER REAR  
**SUITABLE FOR :** MAHINDRA ALFA  
**STD. PACK :** 40



**PART NO. :** 2805104001  
**APPLICATION :** MINOR KIT FOR WHEEL CYLINDER REAR  
**SUITABLE FOR :** MAHINDRA ALFA  
**STD. PACK :** 40



**PART NO. :** 2805104101  
**APPLICATION :** MAJOR KIT FOR WHEEL CYLINDER FRONT  
**SUITABLE FOR :** MAHINDRA ALFA  
**STD. PACK :** 40



**PART NO. :** 2805104201  
**APPLICATION :** MINOR KIT FOR WHEEL CYLINDER FRONT  
**SUITABLE FOR :** MAHINDRA ALFA  
**STD. PACK :** 40



**PART NO. :** 2805101501  
**APPLICATION :** MAJOR KIT WHEEL CYLINDER FRONT  
**SUITABLE FOR :** BAJAJ MAXIMA  
**STD. PACK :** 40



**PART NO. :** 2805105375  
**APPLICATION :** MINOR KIT WHEEL CYLINDER  
**SUITABLE FOR :** BAJAJ MAXIMA / CARGO  
**STD. PACK :** 40



**PART NO. :** 2805101601  
**APPLICATION :** MINOR KIT WHEEL CYLINDER FRONT  
**SUITABLE FOR :** BAJAJ MAXIMA  
**STD. PACK :** 40



**PART NO. :** 2805100901  
**APPLICATION :** RATCHET KIT FRONT/ REAR LH  
**SUITABLE FOR :** BAJAJ 3W  
**STD. PACK :** 100



**PART NO. :** 2805101201  
**APPLICATION :** RATCHET KIT REAR RH  
**SUITABLE FOR :** BAJAJ 3W  
**STD. PACK :** 100

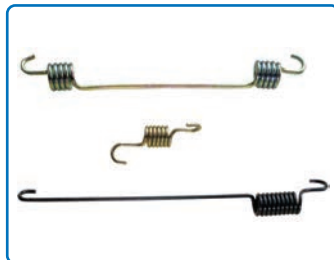

**PART NO. :** 2805101701  
**APPLICATION :** SPRING KIT  
**SUITABLE FOR :** BAJAJ MAXIMA / CARGO  
**STD. PACK :** 50



**PART NO. :** 2805102401  
**APPLICATION :** SPRING KIT - RH  
**SUITABLE FOR :** BAJAJ MAXIMA / CARGO  
**STD. PACK :** 50



**PART NO. :** 2805104801  
**APPLICATION :** WHEEL CYLINDER MAJOR KIT RR  
**DIA 170**  
**SUITABLE FOR :** ATUL AUTO  
**STD. PACK :** 40

# 2 & 3 WHEELER BRAKE PARTS



**ENDURANCE**  
Complete Solutions

## 3 WHEELER BRAKE KIT



**PART NO. :** 2805106075  
**APPLICATION :** MAJOR KIT  
WHEEL CYLINDER  
**SUITABLE FOR :** BAJAJ MAXIMA /  
CARGO  
**STD. PACK :** 40



**PART NO. :** B358004000  
**APPLICATION :** AUTO  
ADJUSTER ASSY - LH (DIA 170)  
**SUITABLE FOR :** ATUL AUTO  
**STD. PACK :** 50



**PART NO. :** B358003000  
**APPLICATION :** AUTO  
ADJUSTER ASSY- RH (DIA 170)  
**SUITABLE FOR :** ATUL AUTO  
**STD. PACK :** 50



**PART NO. :** B358005000  
**APPLICATION :** AUTO  
ADJUSTER ASSY Ø180  
**SUITABLE FOR :** ATUL GEM  
**STD. PACK :** 50



**PART NO. :** B358006000  
**APPLICATION :** AUTO  
ADJUSTER ASSY-RH Ø180  
**SUITABLE FOR :** ATUL GEM  
**STD. PACK :** 50



**PART NO. :** B358007000  
**APPLICATION :** AUTO  
ADJUSTER ASSY FRONT-Ø 180  
**SUITABLE FOR :** ATUL AUTO  
**STD. PACK :** 50

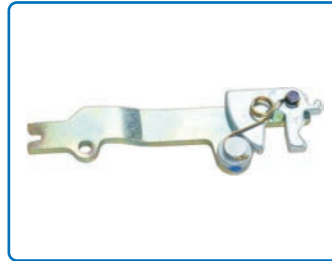

**PART NO. :** 2841500101  
**APPLICATION :** STRUT ASSY  
FRONT  
**SUITABLE FOR :** BAJAJ  
3W 2 STROKE, 175 / RE 205 /  
COMPACT  
**STD. PACK :** 50

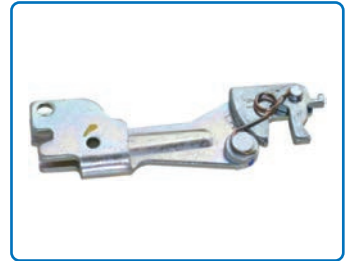

**PART NO. :** 2805107775  
**APPLICATION :** STRUT ASSY  
REAR - LH (NEW TYPE)  
**SUITABLE FOR :** BAJAJ  
3W 2 STROKE, 175 / RE 205 /  
COMPACT  
**STD. PACK :** 50



**PART NO. :** 2861500101  
**APPLICATION :** STRUT ASSY  
AUTO ADJ LH  
**SUITABLE FOR :** BAJAJ MAXIMA /  
CARGO  
**STD. PACK :** 50



**PART NO. :** 2805101101  
**APPLICATION :** PARKING LEVER  
ASSY -REAR LH  
**SUITABLE FOR :** BAJAJ  
3W 2 STROKE, 175 / RE 205 /  
COMPACT  
**STD. PACK :** 50



**PART NO. :** 2805101401  
**APPLICATION :** PARKING  
LEVER ASSY -REAR RH  
**SUITABLE FOR :** BAJAJ  
3W 2 STROKE, 175 / RE 205 /  
COMPACT  
**STD. PACK :** 50



**PART NO. :** 2805107875  
**APPLICATION :** STRUT ASSY  
REAR- RH (NEW TYPE)  
**SUITABLE FOR :** BAJAJ  
3W 2 STROKE, 175 / RE 205 /  
COMPACT  
**STD. PACK :** 50



**PART NO. :** 420RF03875  
**APPLICATION :** PARKING  
LEVER ASSY LH  
**SUITABLE FOR :** BAJAJ  
COMPACT / COMPACT +  
**STD. PACK :** 50



**PART NO. :** 420RF03975  
**APPLICATION :** PARKING  
LEVER ASSY RH  
**SUITABLE FOR :** BAJAJ  
COMPACT / COMPACT +  
**STD. PACK :** 50



**PART NO. :** 2861500201  
**APPLICATION :** STRUT ASSY  
AUTO ADJ RH  
**SUITABLE FOR :** BAJAJ MAXIMA /  
CARGO  
**STD. PACK :** 50



**PART NO. :** 2861500301  
**APPLICATION :** STRUT ASSY  
AUTO ADJ FRONT  
**SUITABLE FOR :** BAJAJ MAXIMA /  
CARGO  
**STD. PACK :** 50

# 2 & 3 WHEELER BRAKE PARTS



**ENDURANCE**  
Complete Solutions

## 3 WHEELER BRAKE KIT



**PART NO. :** 2805104701  
**APPLICATION :** MAJOR KIT FOR WHEEL CYLINDER FRONT  
**SUITABLE FOR :** TVS-KING 2 STROKE / 4 STROKE  
**STD. PACK :** 40



**PART NO. :** 2805100101  
**APPLICATION :** MAJOR KIT FOR WHEEL CYLINDER REAR  
**SUITABLE FOR :** BAJAJ-3W 2 STROKE, 175 / RE 205 / COMPACT  
**STD. PACK :** 40



**PART NO. :** 2805100301  
**APPLICATION :** MINOR KIT FOR WHEEL CYLINDER REAR  
**SUITABLE FOR :** BAJAJ-3W 2 STROKE, 175 / RE 205 / COMPACT  
**STD. PACK :** 40



**PART NO. :** 2805100201  
**APPLICATION :** MAJOR KIT FOR WHEEL CYLINDER FRONT  
**SUITABLE FOR :** BAJAJ-3W 2 STROKE, 175 / RE 205 / COMPACT  
**STD. PACK :** 40



**PART NO. :** 2805100401  
**APPLICATION :** MINOR KIT WHEEL CYLINDER FRONT  
**SUITABLE FOR :** BAJAJ 3W 2 STROKE / 3W 4 STROKE  
**STD. PACK :** 40



**PART NO. :** 2805100801  
**APPLICATION :** SHOE CLAMP SPRING KIT  
**SUITABLE FOR :** BAJAJ 3W 2 STROKE / 3W 4 STROKE  
**STD. PACK :** 100

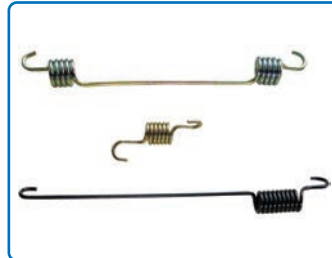

**PART NO. :** 2805101001  
**APPLICATION :** SPRING KIT FRONT / REAR LH  
**SUITABLE FOR :** BAJAJ 3W 2 STROKE / 3W 4 STROKE  
**STD. PACK :** 50



**PART NO. :** 2805101301  
**APPLICATION :** SPRING KIT REAR RH  
**SUITABLE FOR :** BAJAJ 3W 2 STROKE / 3W 4 STROKE  
**STD. PACK :** 50



**PART NO. :** 3005100801  
**APPLICATION :** MAJOR KIT TMC  
**SUITABLE FOR :** PIAGGIO-APE  
**STD. PACK :** 30



**PART NO. :** 3005100901  
**APPLICATION :** MINOR KIT TMC  
**SUITABLE FOR :** PIAGGIO-APE  
**STD. PACK :** 40



**PART NO. :** 3005100601  
**APPLICATION :** MAJOR KIT TMC  
**SUITABLE FOR :** TVS-KING 4 STROKE  
**STD. PACK :** 30



**PART NO. :** 3005100701  
**APPLICATION :** MINOR KIT TMC  
**SUITABLE FOR :** TVS-KING 4 STROKE  
**STD. PACK :** 40



**PART NO. :** 3005101101  
**APPLICATION :** MAJOR KIT TMC  
**SUITABLE FOR :** MAHINDRA ALFA  
**STD. PACK :** 30



**PART NO. :** 3005101001  
**APPLICATION :** MINOR KIT TMC  
**SUITABLE FOR :** MAHINDRA ALFA  
**STD. PACK :** 40



**PART NO. :** 3005100101  
**APPLICATION :** MAJOR KIT TMC  
**SUITABLE FOR :** BAJAJ 3W 2 STROKE / 3W 4 STROKE  
**STD. PACK :** 30



**PART NO. :** 3005100201  
**APPLICATION :** MINOR KIT TMC  
**SUITABLE FOR :** BAJAJ 3W 2 STROKE / 3W 4 STROKE  
**STD. PACK :** 40

# 2 & 3 WHEELER BRAKE PARTS



**ENDURANCE**  
Complete Solutions

## 3 WHEELER BRAKE SHOE



**PART NO. :** 520AM01581  
**APPLICATION :** 3WH BRAKE SHOE KIT  
**SUITABLE FOR :** BAJAJ-3W 2 STROKE / 3W 4 STROKE  
**STD. PACK :** 18



**PART NO. :** 2905104475  
**APPLICATION :** 3WH BRAKE SHOE KIT  
**SUITABLE FOR :** 3WH BRAKE SHOE KIT  
**STD. PACK :** 21



**PART NO. :** 2905104575  
**APPLICATION :** 3WH BRAKE SHOE SET  
**SUITABLE FOR :** BAJAJ GC 1000  
**STD. PACK :** 21



**PART NO. :** 520AM01580  
**APPLICATION :** 3WH BRAKE SHOE SET  
**SUITABLE FOR :** BAJAJ-3W 2 STROKE / 3W 4 STROKE  
**STD. PACK :** 32



**PART NO. :** 2905104975  
**APPLICATION :** BRAKE SHOE LH-RH-FR  
**SUITABLE FOR :** TVS KING  
**STD. PACK :** 14



**PART NO. :** 520AM01395  
**APPLICATION :** BRAKE SHOE FRONT  
**SUITABLE FOR :** PIAGGIO APE  
**STD. PACK :** 15



**PART NO. :** 520AM01396  
**APPLICATION :** BRAKE SHOE REAR LH  
**SUITABLE FOR :** PIAGGIO APE  
**STD. PACK :** 15



**PART NO. :** 520AM01397  
**APPLICATION :** BRAKE SHOE REAR RH  
**SUITABLE FOR :** PIAGGIO APE  
**STD. PACK :** 15



**PART NO. :** 520AM01398  
**APPLICATION :** BRAKE SHOE CTY FRONT  
**SUITABLE FOR :** PIAGGIO APE CITY  
**STD. PACK :** 15



**PART NO. :** 520AM01399  
**APPLICATION :** BRAKE SHOE CTY REAR LH  
**SUITABLE FOR :** PIAGGIO APE CITY  
**STD. PACK :** 15



**PART NO. :** 520AM01400  
**APPLICATION :** BRAKE SHOE CTY REAR RH  
**SUITABLE FOR :** PIAGGIO APE CITY  
**STD. PACK :** 15



**PART NO. :** 2905102775  
**APPLICATION :** BRAKE SHOE LH-RH-FR  
**SUITABLE FOR :** MAHINDRA ALFA  
**STD. PACK :** 14



# 2 & 3 WHEELER BRAKE PARTS



**ENDURANCE**  
Complete Solutions

## 3 WHEELER BRAKE SHOE - ASBESTOS FREE



**PART NO. :** 2905101675  
**APPLICATION :** BRAKE SHOE SET  
**SUITABLE FOR :** BAJAJ-3W 2 STROKE / 3W 4 STROKE  
**STD. PACK :** 18

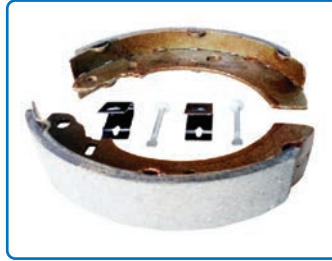

**PART NO. :** 2905107575  
**APPLICATION :** BRAKE SHOE KIT FRONT  
**SUITABLE FOR :** BAJAJ-MAXIMA CARGO  
**STD. PACK :** 15



**PART NO. :** 2905107675  
**APPLICATION :** BRAKE SHOE KIT REAR RH  
**SUITABLE FOR :** BAJAJ-MAXIMA CARGO  
**STD. PACK :** 2



**PART NO. :** 2905107775  
**APPLICATION :** BRAKE SHOE KIT REAR LH  
**SUITABLE FOR :** BRAKE SHOE KIT REAR LH  
**STD. PACK :** 15



**PART NO. :** 2905107875  
**APPLICATION :** BRAKE SHOE KIT FRONT  
**SUITABLE FOR :** BAJAJ-MAXIMA  
**STD. PACK :** 15



**PART NO. :** 2905107975  
**APPLICATION :** BRAKE SHOE KIT REAR RH  
**SUITABLE FOR :** BAJAJ-MAXIMA  
**STD. PACK :** 15



**PART NO. :** 2905108075  
**APPLICATION :** BRAKE SHOE KIT REAR LH  
**SUITABLE FOR :** BAJAJ-MAXIMA  
**STD. PACK :** 15



**PART NO. :** 520AM01485  
**APPLICATION :** BRAKE SHOE FRONT  
**SUITABLE FOR :** PIAGGIO APE  
**STD. PACK :** 15



**PART NO. :** 520AM01486  
**APPLICATION :** BRAKE SHOE REAR LH  
**SUITABLE FOR :** PIAGGIO APE  
**STD. PACK :** 15



**PART NO. :** 520AM01487  
**APPLICATION :** BRAKE SHOE REAR RH  
**SUITABLE FOR :** PIAGGIO APE  
**STD. PACK :** 15



**PART NO. :** 520AM01488  
**APPLICATION :** BRAKE SHOE FRONT  
**SUITABLE FOR :** PIAGGIO APE CITY  
**STD. PACK :** 15



**PART NO. :** 520AM01489  
**APPLICATION :** BRAKE SHOE REAR LH  
**SUITABLE FOR :** BRAKE SHOE REAR LH  
**STD. PACK :** 15



**PART NO. :** 520AM01490  
**APPLICATION :** BRAKE SHOE REAR RH  
**SUITABLE FOR :** BRAKE SHOE REAR RH  
**STD. PACK :** 15



**PART NO. :** 2905101775  
**APPLICATION :** BRAKE SHOE KIT (NON ASBESTOS E-MARK)  
**STD. PACK :** 32

# 2 & 3 WHEELER BRAKE PARTS



**ENDURANCE**  
Complete Solutions

## 3 WHEELER BRAKE SPARES



**PART NO. :** 420QJ00375  
**APPLICATION :** CYLINDER  
PISTON W/O SEAL RR  
**SUITABLE FOR :** BAJAJ 3WH  
**STD. PACK :** 40



**PART NO. :** 420QJ00475  
**APPLICATION :** CYLINDER  
PISTON W/O SEAL FR  
**SUITABLE FOR :** BAJAJ 3WH  
**STD. PACK :** 40



**PART NO. :** B354007000  
**APPLICATION :** TMC ASSY  
**SUITABLE FOR :** PIAGGIO-APE  
**STD. PACK :** 6



**PART NO. :** B354010000  
**APPLICATION :** TMC ASSEMBLY  
DIA 22  
**SUITABLE FOR :** ATUL AUTO  
**STD. PACK :** 6



**PART NO. :** B354011000  
**APPLICATION :** TMC ASSEMBLY  
WITH RESERVOIR - DIA 19.05  
**SUITABLE FOR :** ATUL GEMINI  
**STD. PACK :** 6



**PART NO. :** B354008000  
**APPLICATION :** TMC ASSY  
**SUITABLE FOR :** MAHINDRA  
ALFA  
**STD. PACK :** 6



**PART NO. :** B354006000  
**APPLICATION :** TMC ASSY  
**SUITABLE FOR :** TVS-KING  
2 STROKE / 4 STROKE  
**STD. PACK :** 6



**PART NO. :** 3031000101  
**APPLICATION :** TMC ASSY  
**SUITABLE FOR :** BAJAJ  
3W 2 STROKE, 175 / RE 205 /  
COMPACT  
**STD. PACK :** 6



**PART NO. :** B354004000  
**APPLICATION :** TMC ASSY  
(FACELIFT)  
**SUITABLE FOR :** BAJAJ  
3W 2 STROKE / 3W 4 STROKE  
**STD. PACK :** 6



**PART NO. :** 3031000301  
**APPLICATION :** TMC ASSY  
**SUITABLE FOR :** BAJAJ  
GC 1000  
**STD. PACK :** 6



**PART NO. :** B354002000  
**APPLICATION :** TMC ASSY  
**SUITABLE FOR :** BAJAJ-3W  
COMPACT  
**STD. PACK :** 6



**PART NO. :** B354003000  
**APPLICATION :** TMC ASSY  
**SUITABLE FOR :** BAJAJ  
MAXIMA  
**STD. PACK :** 6



**PART NO. :** B354001000  
**APPLICATION :** TMC ASSY  
**SUITABLE FOR :** BAJAJ  
OPTIMA  
**STD. PACK :** 6



**PART NO. :** B354016000  
**APPLICATION :** TMC ASSY FRONT  
**SUITABLE FOR :** BAJAJ MAXIMA Z /  
COMPACT +  
**STD. PACK :** 6



**PART NO. :** 420HM00175  
**APPLICATION :** RESERVOIR  
WITH CAP (TMC)  
**SUITABLE FOR :** BAJAJ  
3W 2 STROKE, 175 / RE 205 /  
COMPACT  
**STD. PACK :** 10



**PART NO. :** B359003000  
**APPLICATION :** RESERVOIR  
WITH CAP  
**SUITABLE FOR :** BAJAJ  
COMPACT + / CARGO  
**STD. PACK :** 10

# 2 & 3 WHEELER BRAKE PARTS



**ENDURANCE**  
Complete Solutions

## 3 WHEELER BRAKE SPARES



**PART NO. :** 424AK00175  
**APPLICATION :** BACK PLATE ASSY -FRONT  
**SUITABLE FOR :** BAJAJ 3W 2 STROKE, 175 / RE 205 / COMPACT  
**STD. PACK :** 2



**PART NO. :** 424AK00475  
**APPLICATION :** BACK PLATE ASSY -FRONT DI  
**SUITABLE FOR :** BAJAJ 3W 2 STROKE / 3W 4 STROKE / COMPACT  
**STD. PACK :** 2



**PART NO. :** 424AK00275  
**APPLICATION :** BACK PLATE ASSY -REAR LH  
**SUITABLE FOR :** BAJAJ 3W 2 STROKE, 175 / RE 205 / COMPACT  
**STD. PACK :** 2



**PART NO. :** 424AK00375  
**APPLICATION :** BACK PLATE ASSY -REAR RH  
**SUITABLE FOR :** BAJAJ 3W 2 STROKE, 175 / RE 205 / COMPACT  
**STD. PACK :** 2



**PART NO. :** 424AK01675  
**APPLICATION :** BACK PLATE ASSY FRONT- (WITH BUSH & SEAL)  
**SUITABLE FOR :** BAJAJ 3W 2 STROKE / 3W 4 STROKE (OLD MODEL)  
**STD. PACK :** 2



**PART NO. :** 424AK01775  
**APPLICATION :** BACK PLATE ASSY -REAR LH  
**SUITABLE FOR :** BAJAJ 3W 2 STROKE / 3W 4 STROKE (OLD MODEL)  
**STD. PACK :** 2



**PART NO. :** 424AK01875  
**APPLICATION :** BACK PLATE ASSY -REAR RH  
**SUITABLE FOR :** BAJAJ 3W 2 STROKE / 3W 4 STROKE (OLD MODEL)  
**STD. PACK :** 2



**PART NO. :** 424AK02075  
**APPLICATION :** BACK PLATE RH  
**SUITABLE FOR :** BAJAJ MAXIMA  
**STD. PACK :** 2



**PART NO. :** 424AK01975  
**APPLICATION :** BACK PLATE LH  
**SUITABLE FOR :** BAJAJ MAXIMA  
**STD. PACK :** 2



**PART NO. :** 426AK00875  
**APPLICATION :** BACK PLATE FR  
**SUITABLE FOR :** BAJAJ MAXIMA  
**STD. PACK :** 2



**PART NO. :** 424AK02475  
**APPLICATION :** BACK PLATE ASSY -REAR LH  
**SUITABLE FOR :** TVS-KING 2 STROKE / 4 STROKE  
**STD. PACK :** 2



**PART NO. :** 424AK02575  
**APPLICATION :** BACK PLATE ASSY -REAR RH  
**SUITABLE FOR :** TVS-KING 2 STROKE / 4 STROKE  
**STD. PACK :** 2



**PART NO. :** 424AK02375  
**APPLICATION :** BACK PLATE ASSY -FRONT  
**SUITABLE FOR :** TVS-KING 2 STROKE / 4 STROKE  
**STD. PACK :** 2

# 2 & 3 WHEELER BRAKE PARTS



**ENDURANCE**  
Complete Solutions

## 3 WHEELER BRAKE SPARES



**PART NO. :** B351023000  
**APPLICATION :** BRAKE PANEL ASSY LH- DIA 180  
**SUITABLE FOR :** ATUL AUTO  
**STD. PACK :** 6



**PART NO. :** B351024000  
**APPLICATION :** BRAKE PANEL ASSY RH- DIA 180  
**SUITABLE FOR :** ATUL AUTO  
**STD. PACK :** 6



**PART NO. :** B351018000  
**APPLICATION :** BRAKE PANEL ASSY LH- DIA 170  
**SUITABLE FOR :** ATUL AUTO  
**STD. PACK :** 6



**PART NO. :** B351019000  
**APPLICATION :** BRAKE PANEL ASSY RH- DIA 170  
**SUITABLE FOR :** ATUL AUTO  
**STD. PACK :** 6



**PART NO. :** B351020000  
**APPLICATION :** PANEL ASSY FRONT - DIA 170  
**SUITABLE FOR :** ATUL AUTO  
**STD. PACK :** 6



**PART NO. :** B351022000  
**APPLICATION :** BRAKE PANEL ASSY FRONT - DIA 180  
**SUITABLE FOR :** ATUL AUTO  
**STD. PACK :** 6



**PART NO. :** 2841200301  
**APPLICATION :** BRAKE PANEL ASSY -REAR RH  
**SUITABLE FOR :** BAJAJ 3W 2 STROKE, 175 / RE 205 / COMPACT  
**STD. PACK :** 6



**PART NO. :** 2841200801  
**APPLICATION :** BRAKE PANEL ASSY -FRONT  
**SUITABLE FOR :** BAJAJ 3W 2 STROKE, 175 / RE 205 / COMPACT  
**STD. PACK :** 6



**PART NO. :** 2841201501  
**APPLICATION :** FRONT PANEL ASSY  
**SUITABLE FOR :** BAJAJ COMPACT  
**STD. PACK :** 2



**PART NO. :** B356001000  
**APPLICATION :** BRAKE PANEL ASSY REAR LH  
**SUITABLE FOR :** BAJAJ COMPACT / COMPACT +  
**STD. PACK :** 6



**PART NO. :** B356002000  
**APPLICATION :** BRAKE PANEL ASSY REAR RH  
**SUITABLE FOR :** BAJAJ COMPACT / COMPACT +  
**STD. PACK :** 6



**PART NO. :** B351038000  
**APPLICATION :** BRAKE PANEL ASSY REAR RH  
**SUITABLE FOR :** BAJAJ COMPACT / COMPACT +  
**STD. PACK :** 6



**PART NO. :** B351014000  
**APPLICATION :** BRAKE PANEL ASSY FRONT  
**SUITABLE FOR :** BAJAJ MAXIMA / CARGO  
**STD. PACK :** 5



**PART NO. :** B351016000  
**APPLICATION :** BRAKE PANEL ASSY REAR LH  
**SUITABLE FOR :** BAJAJ MAXIMA / CARGO  
**STD. PACK :** 6



**PART NO. :** 2841201201  
**APPLICATION :** BRAKE PANEL ASSY FRONT  
**SUITABLE FOR :** BAJAJ MAXIMA Z / COMPACT +  
**STD. PACK :** 5



**PART NO. :** 2841200201  
**APPLICATION :** BRAKE PANEL ASSY -REAR LH  
**SUITABLE FOR :** BAJAJ 3W 2 STROKE, 175 / RE 205 / COMPACT  
**STD. PACK :** 6

# 2 & 3 WHEELER BRAKE PARTS



**ENDURANCE**  
Complete Solutions

## 3 WHEELER BRAKE SPARES



**PART NO. :** B357004000  
**APPLICATION :** WHEEL  
CYLINDER ASSY - RR DIA 25.4  
**SUITABLE FOR :** ATUL AUTO  
**STD. PACK :** 30



**PART NO. :** B357006000  
**APPLICATION :** WHEEL  
CYLINDER ASSLY- Ø25.4  
**SUITABLE FOR :** ATUL GEM  
**STD. PACK :** 30



**PART NO. :** 2851400201  
**APPLICATION :** WHEEL  
CYLINDER - FRONT  
**SUITABLE FOR :** BAJAJ  
3W 2 STROKE, 175 / RE 205 /  
COMPACT  
**STD. PACK :** 30



**PART NO. :** 2871400201  
**APPLICATION :** WHEEL  
CYLINDER- REAR  
**SUITABLE FOR :** BAJAJ  
3W 2 STROKE, 175 / RE 205 /  
COMPACT  
**STD. PACK :** 30



**PART NO. :** 2831400101  
**APPLICATION :** WHEEL  
CYLINDER ASSLY FRONT  
**SUITABLE FOR :** BAJAJ MAXIMA  
**STD. PACK :** 30



**PART NO. :** 2831400201  
**APPLICATION :** WHEEL  
CYLINDER ASSLY REAR RH  
**SUITABLE FOR :** BAJAJ MAXIMA  
**STD. PACK :** 30



**PART NO. :** 2851400601  
**APPLICATION :** WHEEL  
CYLINDER ASSLY FRONT  
**SUITABLE FOR :** BAJAJ MAXIMA /  
CARGO  
**STD. PACK :** 30



**PART NO. :** 2871400601  
**APPLICATION :** WHEEL  
CYLINDER ASSY  
**SUITABLE FOR :** TVS-KING  
2 STROKE / 4 STROKE  
**STD. PACK :** 30



**PART NO. :** 2851400301  
**APPLICATION :** WHEEL  
CYLINDER ASSY- REAR  
**SUITABLE FOR :** MAHINDRA  
ALFA  
**STD. PACK :** 30



**PART NO. :** 2871400501  
**APPLICATION :** WHEEL  
CYLINDER ASSY - REAR  
**SUITABLE FOR :** PIAGGIO-APE  
**STD. PACK :** 30



**PART NO. :** 2851400401  
**APPLICATION :** WHEEL  
CYLINDER ASSY - FRONT  
**SUITABLE FOR :** PIAGGIO-APE  
**STD. PACK :** 30



**PART NO. :** 2871400401  
**APPLICATION :** WHEEL  
CYLINDER ASSY- FRONT  
**SUITABLE FOR :** MAHINDRA  
ALFA  
**STD. PACK :** 30

# Control Cables



## Types of Control Cables

CLUTCH CABLE ASSEMBLY



ACCELATOR CABLE ASSEMBLY



FRONT BRAKE CABLE ASSEMBLY



CHOKE CABLE ASSEMBLY



SEAT LOCK CABLE ASSEMBLY



SPEEDO CABLE ASSEMBLY



# CONTROL CABLE



## CONTROL CABLES - 2 WHEELER

HERO			
ETL PART NO	APPLICATION	SUITABLE FOR	STD PACKING
520AM00138	ACCELERATOR CABLE	HERO CD-100	25
520AM00156	CLUTCH CABLE	HERO CD-100	25
520AM00183	FRONT BRAKE CABLE WITH NUT	HERO CD-100	25
520AM00181	SPEEDOMETER CABLE	HERO CD-100	25
520AM00139	ACCELERATOR CABLE	HERO SPLENDOR/SPLENDOR +/PASSION/PASSION +	25
520AM00157	CLUTCH CABLE HERO	SPLENDOR/SPLENDOR +/PASSION/PASSION +	25
520AM00185	FRONT BRAKE CABLE	HERO SPLENDOR/SPLENDOR +/PASSION/PASSION +	25
520AM00171	SPEEDOMETER CABLE	HERO SPLENDOR/SPLENDOR +/PASSION/PASSION +	25
520AM00147	ACCELERATOR CABLE	HERO SPLENDOR PRO/PASSION PRO	25
520AM00164	CLUTCH CABLE HERO	SPLENDOR PRO/PASSION PRO	25
520AM00972	SEAT LOCK CABLE	HERO SPLENDOR PRO/PASSION PRO	25
520AM00194	FRONT BRAKE CABLE	HERO SPLENDOR PRO/PASSION PRO	25
520AM00177	SPEEDO CABLE	HERO PASSION PRO	25
520AM00607	SPEEDO CABLE	HERO SPLENDOR PRO	25
520AM00140	ACCELERATOR CABLE	HERO CBZ	25
520AM00158	CLUTCH CABLE	HERO CBZ	25
520AM00186	FRONT BRAKE CABLE	HERO CBZ	25
520AM00181	SPEEDOMETER CABLE	HERO CBZ	25
520AM00619	SEAT LOCK CABLE	HERO CBZ	25
520AM00148	ACCELERATOR CABLE	HERO CBZ XTRME	25
520AM00163	CLUTCH CABLE	HERO CBZ XTRME	25
520AM00154	CHOKE CABLE	HERO CBZ XTRME	25
520AM00176	SPEEDOMETER CABLE	HERO CBZ XTRME	25
520AM00197	SEAT LOCK CABLE	HERO CBZ XTRME	25
520AM00627	ACCELERATOR CABLE	HERO AMBITION/AMBITION 135	25
520AM00626	CLUTCH CABLE	HERO AMBITION/AMBITION 135	25
520AM00625	FRONT BRAKE CABLE	HERO AMBITION/AMBITION 135	25
520AM00181	SPEEDOMETER CABLE	HERO AMBITION/AMBITION 135	25
520AM00619	SEAT LOCK CABLE	HERO AMBITION/AMBITION 135	25
520AM00139	ACCELERATOR CABLE	HERO CD-DAWN/JOY	25
520AM00157	CLUTCH CABLE	HERO CD-DAWN/JOY	25
520AM00184	FRONT BRAKE CABLE	HERO CD-DAWN/JOY	25
520AM00617	SPEEDOMETER CABLE	HERO CD-DAWN/JOY	25
520AM00616	SEAT LOCK CABLE	HERO CD-DAWN/JOY	25
520AM00143	ACCELERATOR CABLE	HERO CD-DELUXE/NXG	25
520AM00157	CLUTCH CABLE	HERO CD-DELUXE/NXG	25
520AM00195	SEAT LOCK CABLE	HERO CD-DELUXE/NXG	25
520AM00188	FRONT BRAKE CABLE	HERO CD-DELUXE/NXG	25
520AM00174	SPEEDOMETER CABLE	HERO CD-DELUXE/NXG	25
520AM00141	ACCELERATOR CABLE OPEN A	HERO KARIZMA OPEN A	25
520AM00150	ACCELERATOR CABLE OPEN B	HERO KARIZMA OPEN B	25
520AM00159	CLUTCH CABLE	HERO KARIZMA	25
520AM00153	CHOKE CABLE	HERO KARIZMA	25
520AM00619	SEAT LOCK CABLE	HERO KARIZMA	25
520AM00181	SPEEDOMETER CABLE	HERO KARIZMA	25
520AM00144	ACCELERATOR CABLE	HERO SUPER SPLENDOR	25
520AM00903	ACCELERATOR CABLE	HERO GLAMOUR	25

# CONTROL CABLE



HERO			
ETL PART NO	APPLICATION	SUITABLE FOR	STD PACKING
520AM00161	CLUTCH CABLE	HERO SUPER SPLENDOR/GLAMOUR	25
520AM00189	FRONT BRAKE CABLE	HERO SUPER SPLENDOR/GLAMOUR	25
520AM00603	SPEEDOMETER CABLE	HERO SUPER SPLENDOR/GLAMOUR	25
520AM00145	ACCELERATOR CABLE	HERO PLEASURE	25
520AM00191	FRONT BRAKE CABLE	HERO PLEASURE	25
520AM00168	REAR BRAKE CABLE	HERO PLEASURE	25
520AM00648	CHOKE CABLE	HERO PLEASURE	25
520AM00175	SPEEDOMETER CABLE	HERO PLEASURE	25
520AM00200	SEAT LOCK CABLE	HERO PLEASURE	25
520AM00636	ACCELERATOR CABLE	HERO ACHIEVER	25
520AM00635	CLUTCH CABLE	HERO ACHIEVER	25
520AM00638	FRONT BRAKE CABLE	HERO ACHIEVER	25
520AM00639	CHOKE CABLE	HERO ACHIEVER	25
520AM00637	SPEEDOMETER CABLE	HERO ACHIEVER	25
520AM00146	ACCELERATOR CABLE	HERO HUNK	25
520AM00162	CLUTCH CABLE	HERO HUNK	25
520AM00154	CHOKE CABLE	HERO HUNK	25
520AM00176	SPEEDOMETER CABLE	HERO HUNK	25
520AM00652	ACCELERATOR CABLE	HERO MSTRO	25
520AM00651	REAR BRAKE CABLE	HERO MSTRO	25
520AM00653	CHOKE CABLE	HERO MSTRO	25
520AM00654	SPEEDOMETER CABLE	HERO MSTRO	25
520AM00973	FRONT BRAKE LH CABLE	HERO MSTRO	25
520AM00974	FRONT BRAKE RH CABLE	HERO MSTRO	25
520AM00641	ACCELERATOR CABLE	HERO IMPULSE	25
520AM00640	CLUTCH CABLE	HERO IMPULSE	25
520AM00642	CHOKE CABLE	HERO IMPULSE	25
520AM00644	ACCELERATOR CABLE	HERO IGNITOR	25
520AM00643	CLUTCH CABLE	HERO IGNITOR	25
520AM00646	CHOKE CABLE	HERO IGNITOR	25
520AM00645	SPEEDOMETER CABLE	HERO IGNITOR	25
520AM00647	SEAT LOCK CABLE	HERO IGNITOR	25
520AM00623	ACCELERATOR CABLE	HERO STREET	25
520AM00622	FRONT BRAKE CABLE	HERO STREET	25
520AM00624	SPEEDOMETER CABLE	HERO STREET	25
520AM00612	ACCELERATOR CABLE	HERO PASSION X-PRO	25
520AM00611	CLUTCH CABLE	HERO PASSION X-PRO	25
520AM00610	FRONT BRAKE CABLE	HERO PASSION X-PRO	25
520AM00633	ACCELERATOR CABLE-A	HERO KARIZMA ZMR-A	25
520AM00632	ACCELERATOR CABLE-B	HERO KARIZMA ZMR-B	25
520AM00631	CLUTCH CABLE	HERO KARIZMA ZMR	25
520AM00153	CHOKE CABLE	HERO KARIZMA ZMR	25
520AM00975	SEAT LOCK CABLE	HERO KARIZMA ZMR	25
BAJAJ			
520AM00726	ACCELERATOR CABLE	BAJAJ KB-100/RTZ/KB-125	25
520AM00727	CLUTCH CABLE	BAJAJ KB-100/RTZ/KB-125	25
520AM00725	FRONT BRAKE CABLE	BAJAJ KB-100/RTZ/KB-125	25



# CONTROL CABLE



BAJAJ			
ETL PART NO	APPLICATION	SUITABLE FOR	STD PACKING
520AM00015	CHOKE CABLE	BAJAJ KB-100/RTZ/KB-125	25
520AM00729	SPEEDOMETER CABLE	BAJAJ KB-100/RTZ/KB-125	25
520AM00012	ACCELERATOR CABLE	BAJAJ KB-4S/BOXER/BOXER-CT/AT	25
520AM00013	CLUTCH CABLE	BAJAJ KB-4S/BOXER/BOXER-CT/AT	25
520AM00009	FRONT BRAKE CABLE	BAJAJ KB-4S/BOXER/BOXER-CT/AT	25
520AM00015	CHOKE CABLE	BAJAJ KB-4S/BOXER/BOXER-CT/AT	25
520AM00016	SPEEDOMETER CABLE	BAJAJ KB-4S/BOXER/BOXER-CT/AT	25
520AM00737	ACCELERATOR CABLE	BAJAJ CALIBER	25
520AM00735	CLUTCH CABLE	BAJAJ CALIBER/CROMA	25
520AM00732	FRONT BRAKE CABLE	BAJAJ CALIBER/CROMA	25
520AM00011	SPEEDOMETER CABLE	BAJAJ CALIBER	25
520AM00733	ACCELERATOR CABLE	BAJAJ CROMA	25
520AM00763	SPEEDOMETER CABLE	BAJAJ CROMA	25
520AM00007	ACCELERATOR CABLE	BAJAJ CALIBER 115	25
520AM00008	CLUTCH CABLE	BAJAJ CALIBER 115	25
520AM00976	FRONT BRAKE CABLE	BAJAJ CALIBER 115	25
520AM00010	CHOKE CABLE	BAJAJ CALIBER 115	25
520AM00011	SPEEDOMETER CABLE	BAJAJ CALIBER 115	25
520AM00739	ACCELERATOR CABLE	BAJAJ PULSAR 150/180	25
520AM00742	CLUTCH CABLE	BAJAJ PULSAR 150/180	25
520AM00738	FRONT BRAKE CABLE	BAJAJ PULSAR 150/180	25
520AM00030	CHOKE CABLE	BAJAJ PULSAR 150/180	25
520AM00977	SEAT LOCK CABLE	BAJAJ PULSAR 150/180	25
520AM00978	SPEEDOMETER CABLE	BAJAJ PULSAR 150/180	25
520AM00028	ACCELERATOR CABLE	BAJAJ PULSAR DTSI 150/180	25
520AM00979	SPEEDOMETER CABLE ASSY	BAJAJ PULSAR DTSI 150/180	25
520AM00029	CLUTCH CABLE	BAJAJ PULSAR DTSI 150/180	25
520AM00732	FRONT BRAKE CABLE	BAJAJ PULSAR DTSI 150/180	25
520AM00030	CHOKE CABLE	BAJAJ PULSAR DTSI 150/180	25
520AM00049	SEAT LOCK CABLE	BAJAJ PULSAR DTSI 150/180	25
520AM00109	ACCELERATOR CABLE	BAJAJ PULSAR 135	25
520AM00111	CLUTCH CABLE	BAJAJ PULSAR 135	25
520AM00047	ACCELERATOR CABLE	BAJAJ PULSAR DTSI 150/180 - UG3	25
520AM00110	CLUTCH CABLE	BAJAJ PULSAR DTSI 150/180 - UG3	25
520AM00744	FRONT BRAKE CABLE	BAJAJ PULSAR DTSI 150/180 - UG3	25
520AM00033	CHOKE CABLE	BAJAJ PULSAR DTSI 150/180 - UG3	25
520AM00745	ACCELERATOR CABLE	BAJAJ PULSAR 220/200	25
520AM00050	CLUTCH CABLE	BAJAJ PULSAR 220/200	25
520AM00055	ACCELERATOR CABLE	BAJAJ PULSAR 180/220 F1	25
520AM00056	CLUTCH CABLE	BAJAJ PULSAR 180/220 F1	25
520AM00051	ACCELERATOR CABLE	BAJAJ PULSAR 200 NS	25
520AM00052	CLUTCH CABLE	BAJAJ PULSAR 200 NS	25
520AM00018	ACCELERATOR CABLE	BAJAJ CT-100/PLATINA	25
520AM00020	FRONT BRAKE CABLE	BAJAJ CT-100/PLATINA	25
520AM00019	CLUTCH CABLE	BAJAJ CT-100/PLATINA	25
520AM00010	CHOKE CABLE	BAJAJ CT-100/PLATINA	25
520AM00022	SPEEDOMETER CABLE	BAJAJ CT-100/PLATINA	25

# CONTROL CABLE



BAJAJ			
ETL PART NO	APPLICATION	SUITABLE FOR	STD PACKING
520AM00237	CLUTCH CABLE	PLATINA 100 ES	25
520AM00238	BRAKE CABLE	PLATINA 100 ES	25
520AM00239	ACCELERATOR CABLE	PLATINA 100 ES	25
520AM00023	ACCELERATOR CABLE	BAJAJ CT-100 DLX	25
520AM00024	CLUTCH CABLE	BAJAJ CT-100 DLX	25
520AM00025	FRONT BRAKE CABLE	BAJAJ CT-100 DLX	25
520AM00026	CHOKE CABLE	BAJAJ CT-100 DLX	25
520AM00022	SPEEDOMETER CABLE	BAJAJ CT-100 DLX	25
520AM00042	ACCELERATOR CABLE	BAJAJ PLATINA-125	25
520AM00043	CLUTCH CABLE	BAJAJ PLATINA-125	25
520AM00044	CHOKE CABLE	BAJAJ PLATINA-125	25
520AM00045	FRONT BRAKE CABLE	BAJAJ PLATINA-125	25
520AM00046	SPEEDOMETER CABLE	BAJAJ PLATINA-125	25
520AM00746	ACCELERATOR CABLE OPEN	BAJAJ WIND-125	25
520AM00747	ACCELERATOR CABLE CLOSE	BAJAJ WIND-125	25
520AM00748	CLUTCH CABLE	BAJAJ WIND-125	25
520AM00980	FRONT BRAKE CABLE	BAJAJ WIND-125	25
520AM00981	SPEEDOMETER CABLE	BAJAJ WIND-125 DRUM	25
520AM00982	SPEEDOMETER CABLE	BAJAJ WND-125 DISC	25
520AM00755	ACCELERATOR CABLE	BAJAJ DSVR-102	25
520AM00756	CLUTCH CABLE	BAJAJ DSVR-102	25
520AM00034	ACCELERATOR CABLE	BAJAJ DSVR-125/135 DTSI	25
520AM00035	CLUTCH CABLE	BAJAJ DSVR-125/135 DTSI	25
520AM00036	FRONT BRAKE CABLE	BAJAJ DSVR-125/135 DTSI	25
520AM00983	SEAT LOCK CABLE	BAJAJ DSVR-125/135 DTSI	25
520AM00037	CHOKE CABLE	BAJAJ DSVR-125/135 DTSI	25
520AM00038	SPEEDOMETER CABLE	BAJAJ DSVR-125/135 DTSI	25
520AM00041	SPEEDOMETER CABLE	BAJAJ DSVR-125/135 DTSI A/W	25
520AM00057	ACCELERATOR CABLE	BAJAJ DSVR-100	25
520AM00759	CLUTCH CABLE	BAJAJ DSVR-100	25
520AM00036	FRONT BRAKE CABLE	BAJAJ DSVR-100	25
520AM00038	SPEEDOMETER CABLE	BAJAJ DSVR-100	25
520AM00059	ACCELERATOR CABLE	BAJAJ DSVR-150	25
520AM00060	CLUTCH CABLE	BAJAJ DSVR-150	25
520AM00036	FRONT BRAKE CABLE	BAJAJ DSVR-150	25
520AM00061	SPEEDOMETER CABLE	BAJAJ DSVR-150	25
520AM00767	ACCELERATOR CABLE	BAJAJ DSVR-100 M	25
520AM00768	CLUTCH CABLE	BAJAJ DSVR-100 M	25
520AM00766	FRONT BRAKE CABLE	BAJAJ DSVR-100 M	25
520AM00764	ACCELERATOR CABLE	BAJAJ DSVR-100 ST	25
520AM00765	CLUTCH CABLE	BAJAJ DSVR-100 ST	25
520AM00750	ACCELERATOR CABLE	BAJAJ DSVR-112/UPG	25
520AM00751	CLUTCH CABLE	BAJAJ DSVR-112/UPG	25
520AM00749	FRONT BRAKE CABLE	BAJAJ DSVR-112/UPG	25
520AM00752	CHOKE CABLE	BAJAJ DSVR-112/UPG	25
520AM00041	SPEEDOMETER CABLE	BAJAJ DSVR-112/UPG	25
520AM00755	ACCELERATOR CABLE	BAJAJ DSVR-125 ST	25

# CONTROL CABLE



BAJAJ			
ETL PART NO	APPLICATION	SUITABLE FOR	STD PACKING
520AM00756	CLUTCH CABLE	BAJAJ DSVR-125 ST	25
520AM00036	FRONT BRAKE CABLE	BAJAJ DSVR-125 ST	25
520AM00062	SPEEDOMETER CABLE	BAJAJ DSVR-125 ST	25
520AM00063	ACCELERATOR CABLE	BAJAJ DSVR-125 M	25
520AM00058	CLUTCH CABLE	BAJAJ DSVR-125 M	25
520AM00036	FRONT BRAKE CABLE	BAJAJ DSVR-125 M	25
520AM00755	ACCELERATOR CABLE	BAJAJ DSVR-125 T	25
520AM00060	CLUTCH CABLE	BAJAJ DSVR-125 T	25
520AM00036	FRONT BRAKE CABLE	BAJAJ DSVR-125 T	25
520AM00062	SPEEDOMETER CABLE	BAJAJ DSVR-125 T	25
520AM00755	ACCELERATOR CABLE	BAJAJ DSVR-150-S/150-F	25
520AM00756	CLUTCH CABLE	BAJAJ DSVR-150-S	25
520AM00762	CLUTCH CABLE	BAJAJ DSVR-150-F	25
520AM00036	FRONT BRAKE CABLE	BAJAJ DSVR-150-S/150-F	25
520AM00984	SEAT LOCK CABLE	BAJAJ DSVR-150-S	25
520AM00985	SEAT LOCK CABLE	BAJAJ DSVR-150-F	25
520AM00777	ACCELERATOR CABLE	BAJAJ AVGR-OLD	25
520AM00776	CLUTCH CABLE	BAJAJ AVGR-OLD	25
520AM00778	CHOKE CABLE	BAJAJ AVGR-OLD	25
520AM00986	SPEEDOMETER CABLE	BAJAJ AVGR-150/180 OLD	25
520AM00987	SPEEDOMETER CABLE	BAJAJ AVGR-200 OLD	25
520AM00988	SPEEDOMETER CABLE	BAJAJ AVGR-220 OLD	25
520AM00775	REAR BRAKE CABLE	BAJAJ AVGR-OLD	25
520AM00989	SPEEDOMETER CABLE	BAJAJ AVGR-NEW STREET/CRUISE	25
520AM00990	ACCELERATOR CABLE	BAJAJ AVGR-NEW STREET/CRUISE	25
520AM00991	CLUTCH CABLE	BAJAJ AVGR-NEW STREET/CRUISE	25
520AM00992	REAR BRAKE CABLE	BAJAJ AVGR-NEW STREET/CRUISE	25
520AM00993	CLUTCH CABLE	BAJAJ ELMATR	25
520AM00994	ACCELERATOR CABLE OPEN	BAJAJ ELMATR OPEN	25
520AM00995	ACCELERATOR CABLE CLOSE	BAJAJ ELMATR CLOSE	25
520AM00996	SPEEDOMETER CABLE	BAJAJ ELMATR	25
520AM00773	ACCELERATOR CABLE OPEN	BAJAJ XCD-125/135 OPEN	25
520AM00774	ACCELERATOR CABLE CLOSE	BAJAJ XCD-125/135 CLOSE	25
520AM00997	ACCELERATOR CABLE CLOSE	BAJAJ XCD-125/135 CLOSE	25
520AM00772	CLUTCH CABLE	BAJAJ XCD-125/135	25
520AM00771	SPEEDOMETER CABLE	BAJAJ XCD-125/135	25
520AM00240	ACCELERATOR CABLE	BAJAJ BXR-150	25
520AM00241	CLUTCH CABLE	BAJAJ BXR-150	25
520AM00998	FRONT BRAKE CABLE	BAJAJ BXR-150	25
520AM00999	SPEEDOMETER CABLE	BAJAJ BXR-150	25
520AM01000	ACCELERATOR CABLE	BAJAJ BXR-100	25
520AM01001	FRONT BRAKE CABLE	BAJAJ BXR-100	25
520AM01003	CLUTCH CABLE	BAJAJ BXR-100	25
520AM01004	CLUTCH CABLE	BAJAJ DKE-200	25
520AM01005	ACCELERATOR CABLE	BAJAJ DKE-200	25
520AM01006	SEAT LOCK CABLE	BAJAJ DKE-200	25
520AM01007	CLUTCH CABLE	BAJAJ DKE-390	25

# CONTROL CABLE



BAJAJ			
ETL PART NO	APPLICATION	SUITABLE FOR	STD PACKING
520AM01008	ACCELERATOR CABLE	BAJAJ DKE-390	25
520AM01006	SEAT LOCK CABLE	BAJAJ DKE-390	25
520AM01009	CLUTCH CABLE	BAJAJ DMNR-400	25
520AM01010	ACCELERATOR CABLE	BAJAJ DMNR-400	25
520AM01011	ACCELERATOR CABLE	BAJAJ V-15/V-12	25
520AM01012	CLUTCH CABLE	BAJAJ V-15/V-12	25
520AM01013	CHOKE CABLE	BAJAJ V-15/V-12	25
520AM00062	SPEEDOMETER CABLE	BAJAJ V-15/V-12	25
HONDA			
520AM00142	ACCELERATOR CABLE	HONDA UNICORN	25
520AM00160	CLUTCH CABLE	HONDA UNICORN	25
520AM00674	CHOKE CABLE	HONDA UNICORN	25
520AM00173	SPEEDOMETER CABLE	HONDA UNICORN	25
520AM00267	ACCELERATOR CABLE	HONDA SHINE	25
520AM00268	CLUTCH CABLE	HONDA SHINE	25
520AM00190	FRONT BRAKE CABLE	HONDA SHINE	25
520AM00699	CHOKE CABLE	HONDA SHINE	25
520AM00269	SPEEDOMETER CABLE	HONDA SHINE	25
520AM01014	ACCELERATOR CABLE	HONDA SHINE-SP	25
520AM00268	CLUTCH CABLE	HONDA SHINE-SP	25
520AM01015	SEAT LOCK CABLE	HONDA SHINE-SP	25
520AM00190	FRONT BRAKE CABLE	HONDA SHINE-SP	25
520AM01016	CHOKE CABLE	HONDA SHINE-SP	25
520AM00706	ACCELERATOR CABLE	HONDA STUNNER	25
520AM00707	CLUTCH CABLE	HONDA STUNNER	25
520AM00705	FRONT BRAKE CABLE	HONDA STUNNER	25
520AM00709	CHOKE CABLE	HONDA STUNNER	25
520AM00708	SPEEDOMETER CABLE	HONDA STUNNER	25
520AM00678	ACCELERATOR CABLE	HONDA TWISTER	25
520AM00677	CLUTCH CABLE	HONDA TWISTER	25
520AM00676	FRONT BRAKE CABLE	HONDA TWISTER	25
520AM00679	CHOKE CABLE	HONDA TWISTER	25
520AM00680	SPEEDOMETER CABLE	HONDA TWISTER	25
520AM00683	ACCELERATOR CABLE	HONDA AVIATOR OLD	25
520AM00684	CLUTCH CABLE NEW	HONDA AVIATOR NEW	25
520AM00681	FRONT BRAKE CABLE	HONDA AVIATOR	25
520AM01017	REAR BRAKE CABLE	HONDA AVIATOR	25
520AM00686	SPEEDOMETER CABLE	HONDA AVIATOR	25
520AM00685	CHOKE CABLE	HONDA AVIATOR	25
520AM00149	ACCELERATOR CABLE	HONDA ACTIVA/DIO	25
520AM00187	FRONT BRAKE CABLE	HONDA ACTIVA/DIO	25
520AM00167	REAR BRAKE CABLE	HONDA ACTIVA/DIO	25
520AM00152	CHOKE CABLE	HONDA ACTIVA/DIO	25
520AM00199	SEAT LOCK CABLE	HONDA ACTIVA/DIO	25
520AM00172	SPEEDOMETER CABLE	HONDA ACTIVA/DIO	25
520AM00137	ACCELERATOR CABLE	HONDA ACTIVA-110/DIO/I ACTIVA	25
520AM00192	FRONT BRAKE CABLE SHORT	HONDA ACTIVA-110/DIO/I ACTIVA	25

# CONTROL CABLE



HONDA			
ETL PART NO	APPLICATION	SUITABLE FOR	STD PACKING
520AM00182	FRONT BRAKE CABLE- LH	HONDA ACTIVA-110/DIO/I ACTIVA	25
520AM00193	FRONT BRAKE CABLE- RH	HONDA ACTIVA-110/DIO/I ACTIVA	25
520AM00155	CHOKE CABLE	HONDA ACTIVA-110/DIO/I ACTIVA	25
520AM00169	REAR BRAKE CABLE NEW	HONDA ACTIVA-110/DIO/I ACTIVA NEW	25
520AM00170	REAR BRAKE CABLE DLX	HONDA ACTIVA-110/DIO/I ACTIVA DLX	25
520AM00178	SPEEDOMETER CABLE	HONDA ACTIVA-110/DIO/I ACTIVA	25
520AM00673	SEAT LOCK CABLE	HONDA ACTIVA-110/DIO/I ACTIVA	25
520AM00689	ACCELERATOR CABLE WITH CARB NUT	HONDA ETERNO	25
520AM00690	CLUTCH CABLE	HONDA ETERNO	25
520AM00694	GEAR CABLE A	HONDA ETERNO	25
520AM00695	GEAR CABLE B	HONDA ETERNO	25
520AM00187	FRONT BRAKE CABLE	HONDA ETERNO	25
520AM00688	REAR BRAKE CABLE	HONDA ETERNO	25
520AM00691	CHOKE CABLE	HONDA ETERNO	25
520AM00692	SEAT LOCK CABLE	HONDA ETERNO	25
520AM00172	SPEEDOMETER CABLE	HONDA ETERNO	25
520AM00701	ACCELERATOR CABLE	HONDA DREAM- YUGA/NEO/CD-110/DX	25
520AM00703	CLUTCH CABLE	HONDA DREAM- YUGA/NEO/CD-110/DX	25
520AM00700	FRONT BRAKE CABLE	HONDA DREAM- YUGA/NEO/CD-110/DX	25
520AM00704	SPEEDOMETER CABLE	HONDA DREAM- YUGA/NEO/CD-110/DX	25
520AM01018	ACCELERATOR CABLE	HONDA ACTIVA-125	25
520AM01019	FRONT BRAKE CABLE- LH	HONDA ACTIVA-125	25
520AM01020	FRONT BRAKE CABLE- RH	HONDA ACTIVA-125	25
520AM01021	REAR BRAKE CABLE - A	HONDA ACTIVA-125	25
520AM01022	REAR BRAKE CABLE - B	HONDA ACTIVA-125	25
520AM01023	REAR BRAKE CABLE - COMBI	HONDA ACTIVA-125	25
520AM00155	CHOKE CABLE	HONDA ACTIVA-125	25
520AM00673	SEAT LOCK CABLE	HONDA ACTIVA-125	25
520AM00714	ACCELERATOR CABLE	HONDA UNICORN DAZZLER	25
520AM00674	CLUTCH CABLE	HONDA UNICORN DAZZLER	25
520AM00722	CLUTCH CABLE	HONDA UNICORN DAZZLER	25
520AM01024	SEAT LOCK CABLE	HONDA UNICORN DAZZLER	25
520AM01025	ACCELERATOR CABLE - A	HONDA CBR 250	25
520AM01026	ACCELERATOR CABLE - B	HONDA CBR 250	25
520AM01027	CLUTCH CABLE	HONDA CBR 250	25
520AM01028	ACCELERATOR CABLE	HONDA CBR-150	25
520AM01029	CLUTCH CABLE	HONDA CBR-150	25
520AM01030	SEAT LOCK CABLE	HONDA CBR-150	25
520AM00710	ACCELERATOR CABLE	HONDA TRIGGER	25
520AM01031	CLUTCH CABLE	HONDA TRIGGER	25
520AM01032	CHOKE CABLE	HONDA TRIGGER	25
520AM01033	ACCELERATOR CABLE	HONDA UNICORN-160	25
520AM01034	CHOKE CABLE	HONDA UNICORN-160	25
520AM01035	CLUTCH CABLE	HONDA UNICORN-160	25
520AM01036	SEAT LOCK CABLE	HONDA UNICORN-160	25
520AM01037	ACCELERATOR CABLE	HONDA HORNET	25

# CONTROL CABLE



HONDA			
ETL PART NO	APPLICATION	SUITABLE FOR	STD PACKING
520AM01038	CHOKE CABLE	HONDA HORNET	25
520AM01039	CLUTCH CABLE	HONDA HORNET	25
520AM01036	SEAT LOCK CABLE	HONDA HORNET	25
TVS			
520AM00782	ACCELERATOR CABLE	TVS SUZUKI AX-100/MAX-100R	25
520AM00781	CLUTCH CABLE	TVS SUZUKI AX-100/MAX-100R	25
520AM00780	FRONT BRAKE CABLE	TVS SUZUKI AX-100/MAX-100R	25
520AM00225	CHOKE CABLE	TVS SUZUKI AX-100/MAX-100R	25
520AM00788	SPEEDOMETER CABLE	TVS SUZUKI AX-100/MAX-100R	25
520AM00791	ACCELERATOR CABLE	TVS SAMURAI	25
520AM01040	ACCELERATOR CABLE	TVS SHOGUN/SHAOLIN	25
520AM00790	CLUTCH CABLE	TVS SAMURAI/SHOGUN/SHAOLIN	25
520AM00789	FRONT BRAKE CABLE	TVS SAMURAI/SHOGUN/SHAOLIN	25
520AM01041	CHOKE CABLE	TVS SAMURAI	25
520AM00792	CHOKE CABLE	TVS SHOGUN/SHAOLIN	25
520AM00788	SPEEDOMETER CABLE	TVS SAMURAI	25
520AM00794	SPEEDOMETER CABLE	TVS SHOGUN/SHAOLIN	25
520AM00220	ACCELERATOR CABLE	TVS VICTOR-GL	25
520AM00219	CLUTCH CABLE	TVS VICTOR-GL	25
520AM00218	FRONT BRAKE CABLE	TVS VICTOR-GL	25
520AM00220	CHOKE CABLE	TVS VICTOR-GL	25
520AM00222	SPEEDOMETER CABLE	TVS VICTOR-GL	25
520AM00221	CHK CABLE ASSY	TVS VCTR GL/GLS 110	25
520AM00821	ACCELERATOR CABLE	TVS VICTOR-GLX 125	25
520AM00820	CLUTCH CABLE	TVS VICTOR-GLX 125	25
520AM00819	FRONT BRAKE CABLE	TVS VICTOR-GLX 125	25
520AM00220	CHOKE CABLE	TVS VICTOR-GLX 125	25
520AM00822	SPEEDOMETER CABLE	TVS VICTOR-GLX 125	25
520AM00825	ACCELERATOR CABLE	TVS CENTRA	25
520AM00824	CLUTCH CABLE	TVS CENTRA	25
520AM00823	FRONT BRAKE CABLE	TVS CENTRA	25
520AM00826	SPEEDOMETER CABLE	TVS CENTRA	25
520AM00829	ACCELERATOR CABLE	TVS STAR/STAR-DLX 100	25
520AM00224	CLUTCH CABLE	TVS STAR/STAR-DLX 100	25
520AM00823	FRONT BRAKE CABLE	TVS STAR/STAR-DLX 100	25
520AM00830	CHOKE CABLE	TVS STAR/STAR-DLX 100	25
520AM00223	SPEEDOMETER CABLE	TVS STAR/STAR-DLX 100	25
520AM00829	ACCELERATOR CABLE	TVS STAR CITY-SPOKE	25
520AM00224	ACCELERATOR CABLE	TVS STAR CITY-SPOKE	25
520AM00823	FRONT BRAKE CABLE	TVS STAR CITY-SPOKE	25
520AM00225	CHOKE CABLE	TVS STAR CITY-SPOKE	25
520AM00223	SPEEDOMETER CABLE	TVS STAR CITY-SPOKE	25
520AM01042	ACCELERATOR CABLE	TVS STAR CITY-A/W	25
520AM00224	CLUTCH CABLE	TVS STAR CITY-A/W	25
520AM00218	FRONT BRAKE CABLE	TVS STAR CITY-A/W	25
520AM00225	CHOKE CABLE	TVS STAR CITY-A/W	25
520AM00822	SPEEDOMETER CABLE	TVS STAR CITY-A/W	25

# CONTROL CABLE



TVS			
ETL PART NO	APPLICATION	SUITABLE FOR	STD PACKING
520AM00226	ACCELERATOR CABLE	TVS STAR CITY-ELE. START	25
520AM00224	CLUTCH CABLE	TVS STAR CITY-ELE. START	25
520AM00218	FRONT BRAKE CABLE	TVS STAR CITY-ELE. START	25
520AM00225	CHOKE CABLE	TVS STAR CITY-ELE. START	25
520AM00822	SPEEDOMETER CABLE	TVS STAR CITY-ELE. START	25
520AM00227	ACCELERATOR CABLE	TVS STAR CITY - KEHIN	25
520AM00226	ACCELERATOR CABLE	TVS STAR CITY- SPACO	25
520AM01043	ACCELERATOR CABLE	TVS STAR CITY-110 CVTi	25
520AM00224	CLUTCH CABLE	TVS STAR CITY-UG/110 CVTi	25
520AM00219	FRONT BRAKE CABLE	TVS STAR CITY-UG/110 CVTi	25
520AM00218	FRONT BRAKE CABLE	TVS STAR CITY-UG/110 CVTi A/W	25
520AM00225	CHOKE CABLE	TVS STAR CITY-UG/110 CVTi	25
520AM00822	SPEDO CABLE	TVS STAR CITY-UG/110 CVTi A/W	25
520AM00223	SPEDO CABLE	TVS STAR CITY-UG/110 CVTi SPK	25
520AM00837	ACCELERATOR CABLE	TVS STAR SPORT	25
520AM00836	CLUTCH CABLE	TVS STAR SPORT	25
520AM00838	CHOKE CABLE	TVS STAR SPORT	25
520AM00823	FRONT BRAKE CABLE SPOKE	TVS STAR SPORT SPOKE	25
520AM00218	FRONT BRAKE CABLE A/W	TVS STAR SPORT A/W	25
520AM00822	SPEEDOMETER CABLE A/W	TVS STAR SPORT A/W	25
520AM00223	SPEEDOMETER CABLE SPOKE	TVS STAR SPORT SPOKE	25
520AM00837	ACCELERATOR CABLE	TVS SPORT	25
520AM00836	CLUTCH CABLE	TVS SPORT	25
520AM01044	FRONT BRAKE CABLE ELE. STRT	TVS SPORT ELE. START	25
520AM00218	FRONT BRAKE CABLE KCK STRT	TVS SPORT KICK START	25
520AM00871	SPEEDOMETER CABLE ELE. STRT	TVS SPORT ELE. START	25
520AM00223	SPEEDOMETER CABLE KCK STRT	TVS SPORT KICK START	25
520AM00838	CHOKE CABLE	TVS SPORT	25
520AM00231	ACCELERATOR CABLE	TVS APACHE	25
520AM00229	CLUTCH CABLE OLD	TVS APACHE OLD	25
520AM00234	CLUTCH CABLE NEW	TVS APACHE NEW	25
520AM00230	FRONT BRAKE CABLE	TVS APACHE	25
520AM00217	CHOKE CABLE	TVS APACHE	25
520AM00852	SPEEDOMETER CABLE DRUM	TVS APACHE DRUM	25
520AM00232	SPEEDOMETER CABLE DISC	TVS APACHE DISC	25
520AM00228	SEAT LOCK CABLE	TVS APACHE	25
520AM01045	ACCELERATOR CABLE	TVS APACHE	25
520AM01046	ACCELERATOR CABLE	TVS APACHE RTR-160 Fi	25
520AM00236	CLUTCH CABLE	TVS APACHE	25
520AM00228	SEAT LOCK CABLE	TVS APACHE	25
520AM00235	CHOKE CABLE	TVS APACHE	25
520AM00866	ACCELERATOR CABLE	TVS FLAME	25
520AM00865	CLUTCH CABLE	TVS FLAME	25
520AM00230	FRONT BRAKE CABLE	TVS FLAME	25
520AM00867	CHOKE CABLE	TVS FLAME	25
520AM00861	ACCELERATOR CABLE	TVS XL SUPER HD	25
520AM00858	FRONT BRAKE CABLE	TVS XL SUPER HD	25

# CONTROL CABLE



TVS			
ETL PART NO	APPLICATION	SUITABLE FOR	STD PACKING
520AM00859	FRONT BRAKE CABLE NEW	TVS XL SUPER HD NEW	25
520AM00860	REAR BRAKE CABLE	TVS XL SUPER HD	25
520AM00862	CHOKE CABLE	TVS XL SUPER HD	25
520AM00863	CHOKE CABLE NEW	TVS XL SUPER HD NEW	25
520AM00864	SPEEDOMETER CABLE	TVS XL SUPER HD	25
520AM00874	ACCELERATOR CABLE	TVS PHOENIX	25
520AM00841	CLUTCH CABLE	TVS PHOENIX	25
520AM00218	FRONT BRAKE CABLE	TVS PHOENIX	25
520AM01047	CHOKE CABLE	TVS PHOENIX	25
520AM01048	ACCELERATOR CABLE KCK STRT	TVS SCOOTY KICK START	25
520AM01049	ACCELERATOR CABLE ELE. STRT	TVS SCOOTY ELE. START	25
520AM00780	FRONT BRAKE CABLE	TVS SCOOTY	25
520AM01050	REAR BRAKE CABLE	TVS SCOOTY KICK START	25
520AM01051	REAR BRAKE CABLE	TVS SCOOTY ELE. START	25
520AM01052	CHOKE CABLE	TVS SCOOTY KICK START	25
520AM01053	CHOKE CABLE	TVS SCOOTY ELE. START	25
520AM01054	CHOKE CABLE	TVS SCOOTY	25
520AM00847	ACCELERATOR CABLE	TVS SCOOTY PEP/+	25
520AM00793	ACCELERATOR CABLE	TVS SCOOTY STREAK	25
520AM00844	FRONT BRAKE CABLE	TVS SCOOTY PEP+/STREAK	25
520AM00845	REAR BRAKE CABLE	TVS SCOOTY PEP+/STREAK	25
520AM00849	SEAT LOCK CABLE	TVS SCOOTY PEP+/STREAK	25
520AM00850	CHOKE CABLE	TVS SCOOTY PEP+/STREAK	25
520AM01055	ACCELERATOR CABLE	TVS SCOOTY DLX	25
520AM00780	FRONT BRAKE CABLE	TVS SCOOTY DLX	25
520AM01050	REAR BRAKE CABLE	TVS SCOOTY DLX	25
520AM01054	SPEEDOMETER CABLE	TVS SCOOTY DLX	25
520AM01056	CHOKE CABLE	TVS SCOOTY DLX	25
520AM00214	ACCELERATOR CABLE	TVS WEGO	25
520AM00877	ACCELERATOR CABLE	TVS JUPITER/ZEST	25
520AM00211	FRONT BRAKE CABLE	TVS WEGO/JUPITER/ZEST	25
520AM00212	REAR BRAKE CABLE	TVS WEGO	25
520AM00878	CHOKE CABLE	TVS WEGO/JUPITER/ZEST	25
520AM00213	SPEEDOMETER CABLE	TVS WEGO/JUPITER/ZEST NEW	25
520AM00216	REAR BRAKE CABLE	TVS JUPITER/ZEST	25
520AM00855	ACCELERATOR CABLE OLD	TVS XL/XT/CHAMP OLD	25
520AM00856	ACCELERATOR CABLE NEW	TVS XL/XT/CHAMP NEW	25
520AM00853	FRONT BRAKE CABLE	TVS XL/XT/CHAMP	25
520AM00854	REAR BRAKE CABLE	TVS XL/XT/CHAMP	25
520AM00857	CHOKE CABLE	TVS XL/XT/CHAMP	25
520AM01057	ACCELERATOR CABLE	TVS XL-100	25
520AM01058	FRONT BRAKE CABLE	TVS XL-100	25
520AM01059	REAR BRAKE CABLE	TVS XL-100	25
520AM01060	CHOKE CABLE	TVS XL-100	25
520AM00799	ACCELERATOR CABLE	TVS FIERO/UPG	25
520AM00795	FRONT BRAKE CABLE OLD	TVS FIERO/UPG OLD	25
520AM00796	FRONT BRAKE CABLE NEW	TVS FIERO/UPG NEW	25



# CONTROL CABLE



TVS			
ETL PART NO	APPLICATION	SUITABLE FOR	STD PACKING
520AM00803	SPEEDOMETER CABLE	TVS FIERO/UPG	25
520AM00804	SPEEDOMETER CABLE DISC	TVS FIERO/UPG DISC	25
520AM00808	CHOKE CABLE	TVS FIERO/UPG	25
520AM00797	CLUTCH CABLE OLD	TVS FIERO/UPG OLD	25
520AM00798	CLUTCH CABLE NEW	TVS FIERO/UPG NEW	25
520AM00807	ACCELERATOR CABLE	TVS FIERO-F2/FX	25
520AM00805	FRONT BRAKE CABLE	TVS FIERO-F2	25
520AM00811	FRONT BRAKE CABLE	TVS FIERO-FX	25
520AM00809	SPEEDOMETER CABLE DRUM	TVS FIERO-F2/FX DRUM	25
520AM00810	SPEEDOMETER CABLE DISC	TVS FIERO-F2/FX DISC	25
520AM00808	CHOKE CABLE	TVS FIERO-F2/FX	25
520AM00812	CLUTCH CABLE	TVS FIERO-FX	25
520AM00806	CLUTCH CABLE	TVS FIERO-F2	25
520AM01061	ACCELERATOR CABLE	TVS APACHE200 RTR	25
520AM01062	CLUTCH CABLE	TVS APACHE200 RTR	25
SUZUKI			
520AM01063	ACCELERATOR CABLE	SUZUKI ACCESS/SWISH-125	25
520AM01064	REAR BRAKE CABLE	SUZUKI ACCESS/SWISH-125	25
520AM01065	FRONT BRAKE CABLE	SUZUKI ACCESS/SWISH-125	25
520AM01066	CHOKE CABLE	SUZUKI ACCESS/SWISH-125	25
520AM01067	SPEEDOMETER CABLE	SUZUKI ACCESS/SWISH-125	25
520AM01068	SEAT LOCK CABLE	SUZUKI ACCESS/SWISH-125	25
520AM01069	ACCELERATOR CABLE	SUZUKI HEAT/ZEUS	25
520AM01070	CLUTCH CABLE	SUZUKI HEAT/ZEUS	25
520AM01071	FRONT BRAKE CABLE	SUZUKI HEAT/ZEUS	25
520AM01072	SEAT LOCK CABLE	SUZUKI HEAT/ZEUS	25
520AM01073	SPEEDOMETER CABLE	SUZUKI HEAT/ZEUS DRUM	25
520AM01074	SPEEDOMETER CABLE	SUZUKI HEAT/ZEUS DISC	25
520AM01076	ACCELERATOR CABLE - A	SUZUKI GS-150 R	25
520AM01077	ACCELERATOR CABLE - B	SUZUKI GS-150 R	25
520AM01078	CLUTCH CABLE	SUZUKI GS-150 R	25
520AM01079	CHOKE CABLE	SUZUKI GS-150 R	25
520AM01080	SEAT LOCK CABLE	SUZUKI GS-150 R	25
520AM01081	ACCELERATOR CABLE	SUZUKI HAYATE	25
520AM01082	CLUTCH CABLE	SUZUKI HAYATE	25
520AM01083	FRONT BRAKE CABLE	SUZUKI HAYATE	25
520AM01084	SEAT LOCK CABLE	SUZUKI HAYATE	25
520AM01085	SPEEDOMETER CABLE	SUZUKI HAYATE	25
520AM01086	ACCELERATOR CABLE	SUZUKI SLING SHOT	25
520AM01087	CLUTCH CABLE	SUZUKI SLING SHOT	25
520AM01088	FRONT BRAKE CABLE	SUZUKI SLING SHOT	25
520AM01089	SEAT LOCK CABLE	SUZUKI SLING SHOT	25
520AM01090	SPEEDOMETER CABLE	SUZUKI SLING SHOT	25
520AM01091	CHOKE CABLE	SUZUKI SLING SHOT	25
520AM01092	ACCELERATOR CABLE	SUZUKI GIXER/SF	25
520AM01093	CLUTCH CABLE	SUZUKI GIXER/SF	25
520AM01094	CHOKE CABLE	SUZUKI GIXER/SF	25

# CONTROL CABLE



SUZUKI			
ETL PART NO	APPLICATION	SUITABLE FOR	STD PACKING
520AM01095	SEAT LOCK CABLE	SUZUKI GIXER/SF	25
YAMAHA			
520AM00888	ACCELERATOR CABLE	YAMAHA RX-100	25
520AM01096	ACCELERATOR CABLE	YAMAHA RXG	25
520AM00887	CLUTCH CABLE	YAMAHA RX-100/RXG	25
520AM00886	FRONT BRAKE CABLE	YAMAHA RX-100/RXG	25
520AM00889	SPEEDOMETER CABLE	YAMAHA RX-100/RXG	25
520AM01097	ACCELERATOR CABLE	YAMAHA YBX-125	25
520AM01098	ACCELERATOR CABLE	YAMAHA YD-125/CRUX/CRUX-R	25
520AM01099	CLUTCH CABLE	YAMAHA YBX-125	25
520AM01100	CLUTCH CABLE	YAMAHA YD-125/CRUX	25
520AM01101	CLUTCH CABLE	YAMAHA CRUXUX-R	25
520AM01103	FRONT BRAKE CABLE	YAMAHA YD-125/CRUX	25
520AM01104	FRONT BRAKE CABLE	YAMAHA YBX/CRUX-R	25
520AM01105	CHOKE CABLE	YAMAHA YBX-125	25
520AM01106	CHOKE CABLE	YAMAHA YD-125/CRUX	25
520AM01107	SPEEDOMETER CABLE	YAMAHA YD-125/CRUX	25
520AM01108	SPEEDOMETER CABLE	YAMAHA YBX-125	25
520AM01109	SPEEDOMETER CABLE	YAMAHA CRUX-R	25
520AM01110	ACCELERATOR CABLE	YAMAHA CRUX-S	25
520AM01111	CLUTCH CABLE	YAMAHA CRUX-S	25
520AM01112	FRONT BRAKE CABLE	YAMAHA CRUX-S	25
520AM01113	SPEEDOMETER CABLE	YAMAHA CRUX-S	25
520AM00892	ACCELERATOR CABLE	YAMAHA ENTICER	25
520AM00891	CLUTCH CABLE	YAMAHA ENTICER	25
520AM00890	FRONT BRAKE CABLE	YAMAHA ENTICER	25
520AM00893	CHOKE CABLE	YAMAHA ENTICER	25
520AM01114	ACCELERATOR CABLE	YAMAHA LIBERO	25
520AM01115	CLUTCH CABLE	YAMAHA LIBERO-UPG	25
520AM01116	CLUTCH CABLE	YAMAHA LIBERO	25
520AM01118	FRONT BRAKE CABLE	YAMAHA LIBERO	25
520AM01119	FRONT BRAKE CABLE	YAMAHA LIBERO-UPG	25
520AM01120	CHOKE CABLE	YAMAHA LIBERO	25
520AM01121	CHOKE CABLE	YAMAHA LIBERO-UPG	25
520AM01122	SPEEDOMETER CABLE	YAMAHA LIBERO	25
520AM01123	SPEEDOMETER CABLE	YAMAHA LIBERO-UPG	25
520AM01124	ACCELERATOR CABLE	YAMAHA FZR/GLADIATOR	25
520AM01125	CLUTCH CABLE	YAMAHA FZR/GLADIATOR	25
520AM01126	FRONT BRAKE CABLE	YAMAHA FZR/GLADIATOR	25
520AM01127	CHOKE CABLE	YAMAHA FZR/GLADIATOR	25
520AM01128	SPEEDOMETER CABLE	YAMAHA FZR	25
520AM01129	SPEEDOMETER CABLE	YAMAHA GLADIATOR	25
520AM00895	ACCELERATOR CABLE	YAMAHA FZ-16	25
520AM00894	CLUTCH CABLE	YAMAHA FZ-16	25
520AM00897	CHOKE CABLE	YAMAHA FZ-16	25
520AM01130	SEAT LOCK CABLE	YAMAHA FZ-16	25
520AM00900	ACCELERATOR CABLE - A	YAMAHA R-15	25

# CONTROL CABLE



YAMAHA			
ETL PART NO	APPLICATION	SUITABLE FOR	STD PACKING
520AM00901	ACCELERATOR CABLE B	YAMAHA R-15	25
520AM00898	CLUTCH CABLE	YAMAHA R-15	25
520AM01131	SEAT LOCK CABLE	YAMAHA R-15	25
520AM01132	ACCELERATOR CABLE	YAMAHA FASCINO	25
520AM01133	ACCELERATOR CABLE	YAMAHA RAY	25
520AM01134	ACCELERATOR CABLE	YAMAHA ALFA	25
520AM01135	REAR BRAKE CABLE	YAMAHA RAY/ALF/FASCINO	25
520AM01136	FRONT BRAKE CABLE	YAMAHA RAY/ALF/FASCINO	25
520AM01137	CHOKE CABLE	YAMAHA RAY/ALF/FASCINO	25
520AM01138	SPEEDOMETER CABLE	YAMAHA RAY/ALF/FASCINO	25
ROYAL ENFIELD			
520AM01139	ACCELERATOR CABLE	REML BULLET-350	25
520AM01140	CLUTCH CABLE	REML BULLET-350	25
520AM01141	FRONT BRAKE CABLE NEW	REML BULLET-350 NEW	25
520AM01142	FRONT BRAKE CABLE OLD	REML BULLET-350 OLD	25
520AM01143	D COMPRESSION CABLE	REML BULLET-350	25
520AM01144	SPEEDOMETER CABLE	REML BULLET-350	25
520AM01145	ACCELERATOR CABLE - MINDA KB	REML BULLET	25
520AM01146	CLUTCH CABLE- MINDA KB	REML BULLET	25
520AM01147	FRONT BRAKE CABLE -MNDK KB NEW	REML BULLET	25
520AM01148	SPEEDOMETER CABLE -MNDK KB	REML BULLET	25
520AM01149	D COMPRESSION CABLE-MNDK KB	REML BULLET	25
520AM01150	ACCELERATOR CABLE	REML BULLET MACHISMO/A-350	25
520AM01151	CLUTCH CABLE	REML BULLET MACHISMO/A-350 OLD	25
520AM01162	CLUTCH CABLE 5 SPEED	REML BULLET MACHISMO/A-350	25
520AM01152	FRONT BRAKE CABLE	REML BULLET MACHISMO/A-350 OLD	25
520AM01153	D COMPRESSION CABLE	REML BULLET MACHISMO	25
520AM01154	COMPRESSION CABLE	REML BULLET MACHISMO-A 350	25
520AM01155	SPEEDOMETER CABLE	REML BULLET MACHISMO/A-350	25
520AM01156	ACCELERATOR CABLE	REML BULLET CITY/LIGHTING-535	25
520AM01157	CLUTCH CABLE	REML BULLET CITY/LIGHTING-535	25
520AM01158	FRONT BRAKE CABLE	REML BULLET CITY/LIGHTING-535	25
520AM01159	D COMPRESSION CABLE	REML BULLET CITY/LIGHTING-535	25
520AM01160	SPEEDOMETER CABLE	REML BULLET CITY/LIGHTING-535	25
520AM01161	ACCELERATOR CABLE WITH BEND	REML BULLET ELECTRA	25
520AM01151	CLUTCH CABLE	REML BULLET ELECTRA	25
520AM01162	CLUTCH CABLE	REML BULLET ELECTRA 5 SPEED	25
520AM01152	FRONT BRAKE CABLE	REML BULLET ELECTRA	25
520AM01163	D COMPRESSION CABLE	REML BULLET ELECTRA	25
520AM01155	SPEEDOMETER CABLE MACHIMO	REML BULLET ELECTRA/MACHISMO	25
520AM01164	SPEEDOMETER CABLE NEW	REML BULLET ELECTRA NEW	25
520AM01165	ACCELERATOR CABLE NEW	REML BULLET THUNDERBIRD NEW	25
520AM01166	ACCELERATOR CABLE BEND	REML BULLET THUNDERBIRD	25
520AM01167	CLUTCH CABLE OLD	REML BULLET THUNDERBIRD OLD	25
520AM01168	CLUTCH CABLE DOUBLE BEND NEW	REML BULLET THUNDERBIRD	25
520AM01169	FRONT BRAKE CABLE	REML BULLET THUNDERBIRD	25
520AM01170	D COMPRESSION CABLE	REML BULLET THUNDERBIRD	25

# CONTROL CABLE



ROYAL ENFIELD			
ETL PART NO	APPLICATION	SUITABLE FOR	STD PACKING
520AM01160	SPEEDOMETER CABLE	REML BULLET THUNDERBIRD	25
520AM01171	ACCELERATOR CABLE NEW	REML BULLET CLASSIC NEW	25
520AM01172	ACCELERATOR CABLE OLD	REML BULLET CLASSIC OLD	25
520AM01173	CLUTCH CABLE	REML BULLET CLASSIC	25
520AM01164	SPEEDOMETER CABLE	REML BULLET CLASSIC	25
520AM01174	ACCELERATOR CABLE	REML BULLET THUNDERBIRD-350	25
520AM01175	ACCELERATOR CABLE	REML BULLET CLASSIC-350	25
520AM01176	ACCELERATOR CABLE	REML BULLET CLASSIC TWIN-500	25
520AM01177	ACCELERATOR CABLE	REML BULLET THUNDERBIRD TWIN-500	25
520AM01161	ACCELERATOR CABLE	REML BULLET ELECTRA	25
520AM01178	CLUTCH CABLE	REML BULLET CLASSIC-350	25
520AM01179	CLUTCH CABLE	REML BULLET 500	25
520AM01180	FRONT BRAKE CABLE	REML BULLET 350/500	25
520AM01181	CLUTCH CABLE	REML BULLET CLASSIC-500	25
520AM01164	SPEEDOMETER CABLE	REML BULLET-UCE	25
		<b>LML</b>	
520AM01182	ACCELERATOR CABLE	LML FREEDOM	25
520AM01183	CLUTCH CABLE	LML FREEDOM	25
520AM01184	CHOKE CABLE	LML FREEDOM	25
520AM01185	SPEEDOMETER CABLE	LML FREEDOM	25
520AM01182	ACCELERATOR CABLE	LML ADRINO/ENRGY/FX	25
520AM01183	CLUTCH CABLE	LML ADRINO/ENRGY/FX	25
520AM01186	CHOKE CABLE	LML ADRINO	25
520AM01184	CHOKE CABLE	LML ENRGY/FX	25
520AM01187	SPEEDOMETER CABLE	LML ADRINO/ENRGY/FX	25
520AM01188	ACCELERATOR CABLE	LML PRIMA-110	25
520AM01189	ACCELERATOR CABLE	LML PRIMA-125	25
520AM01190	CLUTCH CABLE	LML PRIMA-110/125	25
520AM01191	CHOKE CABLE	LML PRIMA-110/125	25
520AM01192	SPEEDOMETER CABLE	LML PRIMA-110/125	25
		<b>MAHINDRA</b>	
520AM01193	ACCELERATOR CABLE	MAHINDRA DURO	25
520AM01194	FRONT BRAKE CABLE	MAHINDRA DURO	25
520AM01195	REAR BRAKE CABLE	MAHINDRA DURO	25
520AM01196	CHOKE CABLE	MAHINDRA DURO	25
520AM01197	SPEEDOMETER CABLE	MAHINDRA DURO	25
520AM01198	ACCELERATOR CABLE	MAHINDRA CENTURO	25
520AM01200	FRONT BRAKE CABLE	MAHINDRA CENTURO	25
520AM01199	CLUTCH CABLE	MAHINDRA CENTURO	25
520AM01201	SPEEDOMETER CABLE	MAHINDRA CENTURO	25
520AM01203	CHOKE CABLE	MAHINDRA CENTURO	25

# CONTROL CABLE



## CONTROL CABLES - 3 WHEELER

ETL PART NO	APPLICATION	SUITABLE FOR	STD PACKING
520AM01204	ACCELERATOR CABLE ASSY	BAJAJ 3-W FRONT ENGINE	25
520AM01205	GEAR CABLE ASSY	BAJAJ 3-W FRONT ENGINE	25
520AM01206	CLUTCH CABLE ASSY	BAJAJ 3-W FRONT ENGINE	25
520AM00129	ACCELERATOR CABLE NEW (5-Port)	BAJAJ 3-W REAR ENGINE	25
520AM00136	SPEEDOMETER CABLE	BAJAJ 3-W REAR ENGINE	25
520AM00128	ACCELERATOR CABLE OLD (3-Port)	BAJAJ 3-W REAR ENGINE	25
520AM01207	CHOKE CABLE ASSY.(OLD)	BAJAJ 3-W REAR ENGINE	25
520AM00131	GEAR CABLE ASSY BLACK	BAJAJ 3-W REAR ENGINE	25
520AM00132	GEAR CABLE ASSY GREY	BAJAJ 3-W REAR ENGINE	25
520AM00134	CLUTCH CABLE ASSY	BAJAJ 3-W REAR ENGINE	25
520AM00124	HAND BRAKE CABLE	BAJAJ 3-W REAR ENGINE	25
520AM00130	REVERSE GEAR CABLE (HEAVY)	BAJAJ 3-W REAR ENGINE	25
520AM01208	ACC Cable (5-PORT) WIRE ROPE	BAJAJ R/E 2-STRK	25
520AM00135	CLUTCH CABLE ASSY	BAJAJ R/E 2-STRK	25
520AM01209	CHOKE CABLE (PLASTIC LEVEL TYPE)	BAJAJ R/E 2-STRK	25
520AM01210	FAREMETER CABLE (BACK)	BAJAJ R/E 2-STRK	25
520AM01211	ACCELERATOR CABLE NEW	BAJAJ R/E 2-STRK 2008 L.P.G.	25
520AM01212	ACCELERATOR CABLE ASSY(MINDA-2006)	BAJAJ R/E 2-STRK 2008 L.P.G.	25
520AM01213	ACCELERATOR CABLE ASSY(VANAZ-2009)	BAJAJ R/E 2-STRK 2008 L.P.G.	25
520AM01214	GEAR CABLE ( WIRE ROPE )	BAJAJ R/E 2-STRK 2008 L.P.G.	25
520AM01215	GEAR CABLE ( WIRE ROPE )	BAJAJ R/E 2-STRK 2008 L.P.G.	25
520AM01216	CLUTCH CABLE	BAJAJ R/E 2-STRK 2008 L.P.G.	25
520AM01217	CLUTCH CABLE	BAJAJ R/E 2-STRK 2008 L.P.G.	25
520AM01218	CLUTCH CABLE	BAJAJ R/E 2-STRK 2008 L.P.G.	25
520AM00201	GEAR CABLE	BAJAJ R/E 2-STRK 2008 L.P.G.	25
520AM00203	GEAR CABLE	BAJAJ R/E 2-STRK 2008 L.P.G.	25
520AM00077	GEAR CABLE	BAJAJ R/E 2-STRK 2008 L.P.G.	25
520AM00074	GEAR CABLE	BAJAJ R/E 2-STRK 2008 L.P.G.	25
520AM01219	CHOKE CABLE ASSY	BAJAJ R/E 2-STRK 2008 L.P.G.	25
520AM00096	SPEEDOMETER CABLE	BAJAJ R/E 2-STRK 2008 L.P.G.	25
520AM00066	ACCELERATOR CABLE SINGLE (WIRE ROPE )	BAJAJ R/E LPG 4-STRK (2006 Model)	25
520AM00069	STROKE CLUTCH CABLE	BAJAJ R/E LPG 4-STRK (2006 Model)	25
520AM01220	ACCELERATOR CABLE SINGLE (WIRE ROPE )	BAJAJ R/E(145 & 145 D) 2 STRK - 2010	25
520AM01221	ACCELERATOR CABLE (DOUBLE TYPE) ASSY	BAJAJ R/E(145 & 145 D) 2 STRK - 2010	25
520AM00076	GEAR CABLE Black (WIRE ROPE )	BAJAJ R/E(145 & 145 D) 2 STRK - 2010	25
520AM00073	GEAR CABLE White(WIRE ROPE )	BAJAJ R/E(145 & 145 D) 2 STRK - 2010	25
520AM01222	CLUTCH CABLE	BAJAJ R/E(145 & 145 D) 2 STRK - 2010	25
520AM01223	CHOKE CABLE ASSY.	BAJAJ R/E(145 & 145 D) 2 STRK - 2010	25
520AM01224	CHOKE CABLE ASSY.	BAJAJ R/E(145 & 145 D) 2 STRK - 2010 / LPG 2008 (KICK START)	25
520AM01225	REVERSE GEAR CABLE	BAJAJ R/E(145 & 145 D) 2 STRK - 2010	25
520AM01226	METER CABLE	BAJAJ R/E(145 & 145 D) 2 STRK - 2010	25
520AM01227	FUEL COCK OPRTNG CABLE (GREY)	BAJAJ R/E(145 & 145 D) 2 STRK - 2010	25
520AM01228	FUEL COCK OPRTNG CABLE (BLACK)	BAJAJ R/E(145 & 145 D) 2 STRK - 2010	25
520AM01229	HAND BRAKE CABLE FRONT	BAJAJ R/E(145 & 145 D) 2 STRK - 2010	25
520AM00106	CHOKE CABLE ASSY	BAJAJ RE145 (4S) LPG GAS	25
520AM01230	CLUTCH CABLE	BAJAJ R/E 2 STRK - 2012 (R/E-145 ES)	25

# CONTROL CABLE



## CONTROL CABLES - 3 WHEELER

ETL PART NO	APPLICATION	SUITABLE FOR	STD PACKING
520AM01231	REVERSE GEAR CABLE	BAJAJ R/E 2 STRK - 2012 (R/E-145 ES)	25
520AM01232	SPEEDOMETER CABLE	BAJAJ R/E 2 STRK - 2012 (R/E-145 ES)	25
520AM01233	Clutch Cable	BAJAJ R/E 2 STRK - 2012 (R/E-145 )	25
520AM01234	GEAR CABLE (WITH ADJ)	BAJAJ R/E - 2 STROKE	25
520AM00204	CLUTCH CABLE	BAJAJ R/E - 2 STROKE	25
520AM01235	ACCELERATOR CABLE ASSY	BAJAJ R/E GDI - 2 STROKE	25
520AM01236	GEAR CABLE WHITE	BAJAJ R/E GDI - 2 STROKE	25
520AM01237	GEAR CABLE BLACK	BAJAJ R/E GDI - 2 STROKE	25
520AM01238	CLUTCH CABLE	BAJAJ R/E GDI - 2 STROKE	25
520AM01239	METER CABLE	BAJAJ R/E GDI - 2 STROKE	25
520AM00064	ACCELERATOR CABLE WIRE ROPE	BJ R/E 4-STRK /CNG (OLD-2004)	25
520AM00071	REVERSE GEAR CABLE	BJ R/E 4-STRK /CNG (OLD-2004)	25
520AM00205	SPEEDOMETER CABLE	BJ R/E 4-STRK /CNG (OLD-2004)	25
520AM00087	CLUTCH CABLE	BJ R/E 4-STRK /CNG (OLD-2004)	25
520AM00206	CHOKE CABLE	BJ R/E 4-STRK /CNG (OLD-2004)	25
520AM01240	CLUTCH CABLE	BAJAJ R/E - 4 STRK - 2010 (R/E-205 & 205 D)	25
520AM00084	ACCELERATOR CABLE ASSY WIRE ROPE	BAJAJ R/E - 4 STRK - 2010 (R/E-205 & 205 D)	25
520AM01241	CHOKE CABLE ASSY	BAJAJ R/E - 4 STRK - 2010 (R/E-205 & 205 D)	25
520AM00083	REVERSE GEAR CABLE ASSY	BAJAJ R/E - 4 STRK - 2010 (R/E-205 & 205 D)	25
520AM01242	METER CABLE	BAJAJ R/E - 4 STRK - 2010 (R/E-205 & 205 D)	25
520AM01243	FUEL COCK OPRPNG CABLE (GREY)	BAJAJ R/E - 4 STRK - 2010 (R/E-205 & 205 D)	25
520AM01244	FUEL COCK OPRPNG CABLE (BLACK)	BAJAJ R/E - 4 STRK - 2010 (R/E-205 & 205 D)	25
520AM01245	FAREMETER CABLE (BACK)	BAJAJ R/E - 4 STRK - 2010 (R/E-205 & 205 D)	25
520AM01246	HAND BRAKE CABLE Front	BAJAJ R/E - 4 STRK - 2010 (R/E-205 & 205 D)	25
520AM00093	CHOKE CABLE ASSY	BAJAJ R/E 4 STRK -2011 (R/E-205 & R/E-205D)	25
520AM01247	ACCELERATOR CABLE ASSY	BAJAJ R/E 4 STRK -2011 (R/E-205 & R/E-205D)	25
520AM00105	GEAR CABLE ASSY- BLACK	BAJAJ R/E 4 STRK -2011 (R/E-205 & R/E-205D)	25
520AM00104	GEAR CABLE ASSY- WHITE	BAJAJ R/E 4 STRK -2011 (R/E-205 & R/E-205D)	25
520AM01248	CLUTCH CABLE	BAJAJ R/E 4 STRK -2011 (R/E-205 & R/E-205D)	25
520AM01249	METER CABLE	BAJAJ R/E 4STRK - 2012 (R/E-205M / CNG/LPG)	25
520AM01250	FAREMETER CABLE (BACK)	BAJAJ R/E 4STRK - 2012 (R/E-205M / CNG/LPG)	25
520AM01251	HAND BRAKE CABLE FRONT	BAJAJ R/E 4STRK - 2012 (R/E-205M / CNG/LPG)	25
520AM00254	CLUTCH CABLE ASSY	BAJAJ G.C.-1000 (MEGA)	25
520AM00257	GEAR CABLE-NEW BLACK	BAJAJ G.C.-1000	25
520AM00256	GEAR CABLE CNG-NEW WHITE	BAJAJ G.C.-1000	25
520AM00244	CLUTCH CABLE ASSY	BAJAJ G.C.-1000	25
520AM00255	ACCELERATOR CABLE ASSY	BAJAJ G.C.-1000	25
520AM00248	D. COMPRESSION CABLE OLD	BAJAJ G.C.-1000	25
520AM00246	D. COMPRESSION CABLE NEW	BAJAJ G.C.-1000	25
520AM00247	ENGINE STOP CABLE	BAJAJ G.C.-1000	25
520AM00245	SPEEDOMETER CABLE ASSY	BAJAJ G.C.-1000	25
520AM01253	REVERSE GEAR CABLE ASSY NEW	BAJAJ DIESEL	25
520AM00250	CLUTCH CABLE ASSY	BAJAJ DIESEL	25
520AM00252	D. COMPRESSION/CHOKE CABLE ASSY	BAJAJ DIESEL	25
520AM00207	CLUTCH CABLE ASSY	BAJAJ DIESEL	25
520AM00253	ENGINE STOP CABLE ASSY	BAJAJ DIESEL	25
520AM00208	ACCELERATOR CABLE ASSY	BAJAJ DIESEL	25

# CONTROL CABLE



## CONTROL CABLES - 3 WHEELER

ETL PART NO	APPLICATION	SUITABLE FOR	STD PACKING
520AM01254	SPEEDOMETER CABLE ASSY	BAJAJ DIESEL	25
520AM00209	GEAR CABLE (CNG)-NEW BLACK ( WIRE ROPE)	BAJAJ DSL/CNG	25
520AM01252	GEAR CABLE (CNG)-NEW WHITE ( WIRE ROPE)	BAJAJ DSL/CNG	25
520AM01255	D. COMPRESSION CABLE ASSY	BAJAJ G.C.-1250 (MEGA)	25
520AM01256	ENGINE STOP CABLE ASSY	BAJAJ G.C.-1250 (MEGA)	25
520AM00251	ACCELERATOR CABLE ASSY	BAJAJ G.C.-1250	25
520AM00258	REVERSE LOCK CABLE ASSY	BAJAJ G.C.-1250	25
520AM01257	CHOKE CABLE ASSY	BAJAJ G.C.-1250	25
520AM01258	HAND BRAKE CABLE (OLD) LT	BAJAJ G.C.-1250	25
520AM01259	HAND BRAKE CABLE (OLD) RT	BAJAJ G.C.-1250	25
520AM01260	HAND BRAKE CABLE (NEW) LT	BAJAJ G.C.-1250	25
520AM01261	HAND BRAKE CABLE (NEW) RT	BAJAJ G.C.-1250	25
520AM01262	ACCELERATOR CABLE ASSY	BAJAJ GC MAX CNG/MEGA	25
520AM00249	GEAR CABLE ASSY	BAJAJ GC MAX CNG/MEGA	25
520AM01263	CLUTCH CABLE ASSY	BAJAJ GC MAX CNG/MEGA	25
520AM01264	REVERSE GEAR CABLE	BAJAJ GC MAX CNG/MEGA	25
520AM01265	REVERSE GEAR CABLE	BAJAJ GC MAX CNG/MEGA	25
520AM01266	CHOKE CABLE ASSY.	BAJAJ GC MAX CNG/MEGA	25
520AM01267	SPEEDOMETER CABLE ASSY	BAJAJ GC MAX CNG/MEGA	25
520AM00107	CLUTCH CABLE ASSY	BAJAJ R/E COMPACT (4-STROKE)	25
520AM01272	CHOKE CABLE ASSY	BAJAJ R/E COMPACT (4-STROKE)	25
520AM00090	SPEEDOMETER CABLE ASSY	BAJAJ R/E COMPACT (4-STROKE)	25
520AM00088	GEAR CABLE ASSY - BLACK	BAJAJ R/E COMPACT (4-STROKE)	25
520AM00086	ACCELERATOR CABLE ASSY	BAJAJ R/E COMPACT (4-STROKE)	25
520AM00089	GEAR CABLE ASSY- WHITE	BAJAJ R/E COMPACT (4-STROKE)	25
520AM00095	REVERSE CABLE ASSY	BAJAJ R/E COMPACT (4-STROKE)	25
520AM01273	REVERSE CABLE ASSY - NEW	BAJAJ R/E COMPACT (4-STROKE)	25
520AM01274	ACCELERATOR CABLE ASSY	BAJAJ R/E COMPACT - 2 STROKE	25
520AM01495	GEAR CABLE - BLK	BAJAJ R/E COMPACT - 2 STROKE	25
520AM01494	GEAR CABLE - WHT	BAJAJ R/E COMPACT - 2 STROKE	25
520AM01275	CLUTCH CABLE ASSY	BAJAJ R/E COMPACT - 2 STROKE	25
520AM01276	REVERSE CABLE ASSY	BAJAJ R/E COMPACT - 2 STROKE	25
520AM01277	SPEEDOMETER CABLE ASSY	BAJAJ R/E COMPACT - 2 STROKE	25
520AM01278	REVERSE GEAR CABLE ASSLY	BAJAJ RE CMCT 4-ST (PETROL) -2016	25
520AM01279	CHOKE CABLE ASSY	BAJAJ RE CMCT 4-ST (PETROL) -2016	25
520AM01282	ACCELERATOR CABLE ASSY- COMPACT	BAJAJ RE COMPACT + / OPTIMA 4-ST- 2014 (PETROL / CNG / LPG)	25
520AM01283	GEAR CABLE ASSY - WHITE	BAJAJ RE COMPACT + / OPTIMA 4-ST- 2014 (PETROL / CNG / LPG)	25
520AM01284	GEAR CABLE ASSY - BLACK	BAJAJ RE COMPACT + / OPTIMA 4-ST- 2014 (PETROL / CNG / LPG)	25
520AM01285	CLUTCH CABLE ASSY (PADLE TYPE)	BAJAJ RE COMPACT + / OPTIMA 4-ST- 2014 (PETROL / CNG / LPG)	25
520AM01286	CHOKE CABLE ASSY.	BAJAJ RE COMPACT + / OPTIMA 4-ST- 2014 (PETROL / CNG / LPG)	25
520AM01287	SPEEDOMETER CABLE ASSLY	BAJAJ RE COMPACT + / OPTIMA 4-ST- 2014 (PETROL / CNG / LPG)	25

# CONTROL CABLE



## CONTROL CABLES - 3 WHEELER

ETL PART NO	APPLICATION	SUITABLE FOR	STD PACKING
520AM01288	HANDLE BRAKE CABLE ASSLY - FRONT	BAJAJ RE COMPACT + / OPTIMA 4-ST- 2014 (PETROL / CNG / LPG)	25
520AM01289	HANDLE BRAKE CABLE ASSLY - REAR LEFT	BAJAJ RE COMPACT + / OPTIMA 4-ST- 2014 (PETROL / CNG / LPG)	25
520AM01290	HANDLE BRAKE CABLE ASSLY - REAR RIGHT	BAJAJ RE COMPACT + / OPTIMA 4-ST- 2014 (PETROL / CNG / LPG)	25
520AM01291	CLUTCH CABLE (HANDLE TYPE)	BAJAJ RE COMPACT + / OPTIMA 4-ST - 2016 (PETROL)	25
520AM01292	GEAR CABLE - BLACK	BAJAJ DIESEL - COMPACT 2014 / THL	25
520AM01293	GEAR CABLE - WHITE	BAJAJ DIESEL - COMPACT 2014 / THL	25
520AM01294	REV. GEAR CABLE ASSY	BAJAJ DIESEL - COMPACT 2014 / THL	25
520AM01295	D. COMPRESSION CABLE ASSY	BAJAJ DIESEL - COMPACT 2014 / THL	25
520AM01296	ENGINESTOP CABLE	BAJAJ DIESEL - COMPACT 2014 / THL	25
520AM01297	SPEEDOMETER CABLE ASSY - COMPACT	BAJAJ DIESEL - COMPACT 2014 / THL	25
520AM01298	SPEEDOMETER CABLE ASSY- THL MODEL	BAJAJ DIESEL - COMPACT 2014 / THL	25
520AM01299	HAND BRAKE FRONT CABLE	BAJAJ DIESEL - COMPACT 2014 / THL	25
520AM00098	HAND BRAKE CABLE RR LEFT	BAJAJ DIESEL - COMPACT 2014 / THL	25
520AM00099	HAND BRAKE CABLE RR RIGHT	BAJAJ DIESEL - COMPACT 2014 / THL	25
520AM01300	ACCELERATOR CABLE	BAJAJ RE-5 GEAR (MAXIMA)	25
520AM01301	CLUTCH CABLE (HANDLE TYPE)	BAJAJ RE-5 GEAR (MAXIMA)	25
520AM01303	CLUTCH CABLE (FOOT TYPE)	BAJAJ RE-5 GEAR (MAXIMA)	25
520AM01304	GEAR CABLE (BLACK)	BAJAJ RE-5 GEAR (MAXIMA)	25
520AM01305	GEAR CABLE (WHITE)	BAJAJ RE-5 GEAR (MAXIMA)	25
520AM01306	REVERSE GEAR CABLE	BAJAJ RE-5 GEAR (MAXIMA)	25
520AM01307	STOP CABLE	BAJAJ RE-5 GEAR (MAXIMA)	25
520AM01308	SPEEDOMETER CABLE	BAJAJ RE-5 GEAR (MAXIMA)	25
520AM01309	CHOKE CABLE ASSY.	BAJAJ RE-5 GEAR (MAXIMA)	25
520AM01421	GEAR CABLE WHITE HAND	BAJAJ MAXIMA	25
520AM01422	GEAR CABLE WHITE HAND	BAJAJ COMPACT	25
520AM01415	GEAR CABLE BLK HAND	BAJAJ COMPACT	25
520AM01423	GEAR CABLE BLK HAND	BAJAJ MAXIMA	25
520AM01491	DECOMPRESSION CABLE	BAJAJ COMPACT	25
520AM01492	HAND CLUTCH CABLE	BAJAJ COMPACT	25
520AM01680	HAND CLUTCH CABLE	BAJAJ MAXIMA	25
520AM01414	GEAR CABLE BLK	BAJAJ MAXI CARGO	25
520AM01413	REVERSE GEAR CABLE	BAJAJ MAXI CARGO	25
520AM01416	SPEEDOMETER CABLE	BAJAJ MAXI CARGO	25
520AM01417	ENGINE STOP CABLE	BAJAJ MAXI CARGO	25
520AM01418	HAND BRAKE CABLE LH	BAJAJ MAXI CARGO	25
520AM01419	ACCELERATOR CABLE	BAJAJ MAXI CARGO	25
520AM01420	GEAR CABLE WHITE	BAJAJ MAXI CARGO	25
520AM01493	HAND CLUTCH CABLE	BAJAJ MAXI CARGO	25
520AM01310	D. COMPRESSION CABLE ASSY	PIAGGIO APE XTRA-LD/DLX	25
520AM00263	ACCELERATOR CABLE ASSY	PIAGGIO APE XTRA-LD/DLX	25
520AM00264	ACCELERATOR CABLE ASSY (GASOLINE)	PIAGGIO APE XTRA-LD/DLX	25
520AM00262	GEAR CABLE ASSY (WITH ADJ)- GREY	PIAGGIO APE XTRA-LD/DLX	25
520AM00261	GEAR CABLE ASSY (WITH ADJ)- BLACK	PIAGGIO APE XTRA-LD/DLX	25



# CONTROL CABLE



## CONTROL CABLES - 3 WHEELER

ETL PART NO	APPLICATION	SUITABLE FOR	STD PACKING
520AM00265	REVERSE GEAR CABLE - WITH ADJ	PIAGGIO APE XTRA-LD/DLX	25
520AM00259	ENGINE STOP CABLE ASSY	PIAGGIO APE XTRA-LD/DLX	25
520AM00260	CLUTCH CABLE ASSY	PIAGGIO APE XTRA-LD/DLX	25
520AM00123	SPEEDOMETER CABLE ASSY	PIAGGIO APE XTRA-LD/DLX	25
520AM00121	CLUTCH CABLE ASSY(NEW)	PIAGGIO APE D-501 & D-600	25
520AM01312	SPEEDOMETER CABLE ASSY	PIAGGIO APE D-501 & D-600	25
520AM01313	CLUTCH CABLE ASSY	PIAGGIO APE D-501 & D-600	25
520AM01314	GEAR CABLE ASSY- BLACK	PIAGGIO APE D-501 & D-600	25
520AM00117	ACCELERATOR CABLE ASSY	PIAGGIO APE D-501 & D-600	25
520AM00115	GEAR CABLE ASSY (WITH ADJ)	PIAGGIO APE D-501 & D-600	25
520AM00122	D. COMPRESSION CABLE ASSY (NEW)	PIAGGIO APE D-501 & D-600	25
520AM00116	CLUTCH CABLE ASSY (OLD)	PIAGGIO APE D-501 & D-600	25
520AM00118	REVERSE GEAR CABLE (With Adj)	PIAGGIO APE D-501 & D-600	25
520AM00120	ENGINE STOP CABLE ASSY	PIAGGIO APE D-501 & D-600	25
520AM00114	HAND BRAKE CABLE	PIAGGIO APE D-501 & D-600	25
520AM00119	GEAR CABLE ASSY- WHITE	PIAGGIO APE D-501 & D-600	25
520AM01315	CLUTCH CABLE ASSY	PIAGGIO APE CITY BS4	25
520AM01316	ACCELERATOR CABLE ASSY	PIAGGIO APE CITY BS4	25
520AM01317	CHOKE CABLE ASSY	PIAGGIO APE CITY BS4	25
520AM01318	GEAR CABLE - BLACK	PIAGGIO APE CITY BS4	25
520AM01319	GEAR CABLE - GREY	PIAGGIO APE CITY BS4	25
520AM01320	REVERSE GEAR CABLE	PIAGGIO APE CITY BS4	25
520AM01321	SPEEDOMETER CABLE	PIAGGIO APE CITY BS4	25
520AM01322	PJO APE DSL CLUTCH CABLE (OLD)	PIAGGIO APE DSL (OLD)	25
520AM01323	PJO APE DSL CLUTCH CABLE (NEW)	PIAGGIO APE DSL (NEW)	25
520AM01324	PJO APE DSL GEAR CABLE	PIAGGIO APE DSL GEAR CABLE	25
520AM01325	PJO APE DSL ACCELERATOR CABLE	PIAGGIO APE DSL ACC. CABLE	25
520AM01326	PJO APE DSL REV. GEAR CABLE	PIAGGIO APE DSL REV. GEAR CABLE	25
520AM01327	PJO APE DSL ACCELERATOR CABLE (CNG)	PIAGGIO APE DSL ACC. CABLE (CNG)	25
520AM01328	PJO APE DSL CHK CABLE	PIAGGIO APE DSL CHK CABLE	25
520AM01329	PJO APE DSL HAND BRAKE CABLE	PIAGGIO APE DSL HND BRAKE CABLE	25
520AM01330	PJO APE DSL STOP CABLE	PIAGGIO APE DSL STOP CABLE	25
520AM01331	PJO APE DSLSPEEDOMETER CABLE	PIAGGIO APE DSL	25
520AM01332	CLUTCH CABLE ASSY	PIAGGIO APE CITY - LPG	25
520AM01333	ACCELERATOR CABLE ASSY	PIAGGIO APE CITY - LPG	25
520AM01334	ACCELERATOR CABLE ASSLY (SMALL)	PIAGGIO APE CITY - LPG	25
520AM01335	ACCELERATOR CABLE ASSLY (GASOLINE)	PIAGGIO APE CITY - LPG	25
520AM01336	GEAR CABLE ASSLY GREY	PIAGGIO APE CITY - LPG	25
520AM01337	SPEEDOMETER CABLE(DSL/LPG)	PIAGGIO APE CITY - LPG	25
520AM01338	D. COMPRESSION CABLE ASSY	PIAGGIO APE CITY - LPG	25
520AM01341	CHOKE CABLE ASSY. (SMALL)	PIAGGIO APE CITY - LPG	25
520AM01342	CHOKE CABLE ASSY.	PIAGGIO APE CITY - LPG	25
520AM01343	CLUTCH CABLE WITHOUT ADJ.	MAHINDRA ALFA DIESEL	25
520AM01344	CLUTCH CABLE WITH ADJ.	MAHINDRA ALFA DIESEL	25
520AM01345	GEAR CABLE	MAHINDRA ALFA DIESEL	25
520AM01346	ACCELERATOR CABLE	MAHINDRA ALFA DIESEL	25
520AM01347	REVERSE GEAR CABLE	MAHINDRA ALFA DIESEL	25

# CONTROL CABLE



## CONTROL CABLES - 3 WHEELER

ETL PART NO	APPLICATION	SUITABLE FOR	STD PACKING
520AM01348	CHOKE CABLLE	MAHINDRA ALFA DIESEL	25
520AM01349	STOP CABLE	MAHINDRA ALFA DIESEL	25
520AM01350	HAND BRAKE CABLE	MAHINDRA ALFA DIESEL	25
520AM01351	SPEEDOMETER CABLE	MAHINDRA ALFA DIESEL	25
520AM01352	CLUTCH CABLE	MAHINDRA GIO	25
520AM01353	ACCELERATOR CABLE	MAHINDRA GIO	25
520AM01354	REVERSE GEAR CABLE	MAHINDRA GIO	25
520AM01355	ENGINE STOP CABLE	MAHINDRA GIO	25
520AM01356	CHOKE CABLE	MAHINDRA GIO	25
520AM01357	SPEEDOMETER CABLE	MAHINDRA GIO	25
520AM01358	ACCELERATOR CABLE ASSY (DIESEL)	MAHINDRA -CHAMPON	25
520AM01359	ACCELERATOR CABLE ASSY (CNG)	MAHINDRA -CHAMPON	25
520AM01360	CLUTCH CABLE ASSY	MAHINDRA -CHAMPON	25
520AM01361	CHOKE CABLE ASSY.	MAHINDRA -CHAMPON	25
520AM01362	D. COMPRESSION CABLE ASSLY	MAHINDRA -CHAMPON	25
520AM01363	ENGINE STOP CABLE ASSLY	MAHINDRA -CHAMPON	25
520AM01364	SPEEDOMETER CABLE Assy	MAHINDRA -CHAMPON	25
520AM01365	ACCELERATOR CABLE ASSY	MAHINDRA ALFA PLUS	25
520AM01366	CLUTCH CABLE ASSLY	MAHINDRA ALFA PLUS	25
520AM01367	GEAR CABLE ASSLY BLACK	MAHINDRA ALFA PLUS	25
520AM01368	REVERSE GEAR CABLE ASSLY	MAHINDRA ALFA PLUS	25
520AM01369	SPEEDOMETER CABLE ASSLY	MAHINDRA ALFA PLUS	25
520AM01370	D. COMPRESSION CABLE ASSLY	MAHINDRA ALFA PLUS	25
520AM01371	ENGINE STOP CABLE ASSLY	MAHINDRA ALFA PLUS	25
520AM01372	ACCELERATOR CABLE ASSY	MAHINDRA ALFA	25
520AM01373	CLUTCH CABLE ASSLY OLD	MAHINDRA ALFA	25
520AM01374	CLUTCH CABLE ASSLY NEW	MAHINDRA ALFA	25
520AM01375	GEAR CABLE ASSLY	MAHINDRA ALFA	25
520AM01376	REVERSE GEAR CABLE ASSLY	MAHINDRA ALFA	25
520AM01377	D. COMPRESSOR CABLE ASSLY	MAHINDRA ALFA	25
520AM01378	ENGINE STOP CABLE ASSLY	MAHINDRA ALFA	25
520AM01379	SPEEDOMETER CABLE ASSY	MAHINDRA ALFA	25
520AM01380	ACCELERATOR CABLE ASSY	ATUL SHAKTI	25
520AM01381	GEAR CABLE ASSY	ATUL SHAKTI	25
520AM01382	CLUTCH CABLE ASSY	ATUL SHAKTI	25
520AM01383	D. COMPRESSION CABLE ASSY	ATUL SHAKTI	25
520AM01384	ENGINESTOP CABLE ASSY	ATUL SHAKTI	25
520AM01385	SPEEDOMETER CABLE	ATUL SHAKTI	25
520AM01386	HAND BRAKE CABLE (SHORT)	ATUL SHAKTI	25
520AM01387	HAND BRAKE CABLE (LONG)	ATUL SHAKTI	25
520AM01388	ACCELERATOR CABLE ASSY- NEW MODEL	ATUL SHAKTI	25
520AM01389	GEAR CABLE ASSY- NEW MODEL	ATUL SHAKTI	25
520AM01390	CLUTCH CABLE ASSY- NEW MODEL	ATUL SHAKTI	25
520AM01391	ACCELERATOR CABLE	ATUL GEMNI	25
520AM01392	GEAR CABLE (BLACK)	ATUL GEMNI	25
520AM01393	GEAR CABLE (WHITE)	ATUL GEMNI	25
520AM01394	CLUTCH CABLE	ATUL GEMNI	25



# Connecting Rod Kit



PIN



NEEDLE ROLLER BEARING



CONNECTING ROD

# CONNECTING ROD KIT

## CONNECTING ROD KIT - TWO WHEELER



**ENDURANCE**  
Complete Solutions

ETL PART NO	APPLICATION	SUITABLE FOR	STD PACKING
520AM00275	CONNECTING ROD KIT	HERO CD / SPLENDOR / SPLENDOR + / NXG / PASSION (STD)	12
520AM00308	CONNECTING ROD KIT	HERO CD / SPLENDOR / SPLENDOR + / NXG / PASSION (001)	12
520AM00309	CONNECTING ROD KIT	HERO CD / SPLENDOR / SPLENDOR + / NXG / PASSION (002)	12
520AM00310	CONNECTING ROD KIT	HERO CD / SPLENDOR / SPLENDOR + / NXG / PASSION (003)	12
520AM00945	CONNECTING ROD KIT	HERO CD / SPLENDOR / SPLENDOR + / NXG / PASSION (004)	12
520AM00946	CONNECTING ROD KIT	HERO CD / SPLENDOR / SPLENDOR + / NXG / PASSION (005)	12
520AM00276	CONNECTING ROD KIT	HERO SUPER SPLENDOR / GLAMOUR(STD)	12
520AM00317	CONNECTING ROD KIT	HERO SUPER SPLENDOR / GLAMOUR (001)	12
520AM00318	CONNECTING ROD KIT	HERO SUPER SPLENDOR / GLAMOUR (002)	12
520AM00947	CONNECTING ROD KIT	HERO SUPER SPLENDOR / GLAMOUR (003)	12
520AM00277	CONNECTING ROD KIT	BAJAJ CT / PLATINA 100 (STD)	10
520AM00300	CONNECTING ROD KIT	BAJAJ CT / PLAINA 100 (001)	10
520AM00301	CONNECTING ROD KIT	BAJAJ CT / PLATINA 100 (002)	10
520AM00948	CONNECTING ROD KIT	BAJAJ CT / PLATINA 100 (003)	10
520AM00286	CONNECTING ROD KIT	BAJAJ CALIBAR (STD)	10
520AM00294	CONNECTING ROD KIT	BAJAJ CALIBAR (001)	10
520AM00295	CONNECTING ROD KIT	BAJAJ CALIBAR (002)	10
520AM00288	CONNECTING ROD KIT	BAJAJ PULSAR 180 /200 / DIGITAL / 220 NS (STD)/AVENGER	10
520AM00282	CONNECTING ROD KIT	BAJAJ BM 150 / XCD 135/ DISCOVER 150 / PULSAR 135 (STD)	10
520AM00296	CONNECTING ROD KIT	BAJAJ BM 150 / XCD 135/ DISCOVER 150 / PULSAR 135 (001)	10
520AM00297	CONNECTING ROD KIT	BAJAJ BM 150 / XCD 135/ DISCOVER 150 / PULSAR 135 (002)	10
520AM00954	CONNECTING ROD KIT	BAJAJ BM 150 / XCD 135/ DISCOVER 150 / PULSAR 135 (003)	10
520AM00283	CONNECTING ROD KIT	BAJAJ PULSAR DTSI - 150 (STD)	10
520AM00305	CONNECTING ROD KIT	BAJAJ PULSAR DTSI - 150 (001)	10
520AM00306	CONNECTING ROD KIT	BAJAJ PULSAR DTSI- 150 (002)	10
520AM00581	CONNECTING ROD KIT	BAJAJ PULSAR DTSI- 150 (003)	10
520AM00284	CONNECTING ROD KIT	BAJAJ PULSAR 220/ BAJAJ 3W4S COMPACT (STD)	10
520AM00307	CONNECTING ROD KIT	BAJAJ PULSAR 220/ BAJAJ 3W4S COMPACT (001)	10
520AM00340	CONNECTING ROD KIT	BAJAJ PULSAR 220/ BAJAJ 3W 4S COMPACT(002)	10
520AM00341	CONNECTING ROD KIT	BAJAJ PULSAR 220/ BAJAJ 3W4S COMPACT(003)	10
520AM00278	CONNECTING ROD KIT	BAJAJ DISCOVER 100 / BM 100 (STD)	10
520AM00314	CONNECTING ROD KIT	BAJAJ DISCOVER 100 / BM 100 (001)	10
520AM00949	CONNECTING ROD KIT	BAJAJ DISCOVER 100 / BM 100 (002)	10
520AM00950	CONNECTING ROD KIT	BAJAJ DISCOVER 100 / BM 100 (003)	10
520AM00378	CONNECTING ROD KIT	BAJAJ PLATINA-125 / XCD-125 (STD)	10
520AM00379	CONNECTING ROD KIT	BAJAJ PLATINA-125 / XCD-125 (001)	10
520AM00380	CONNECTING ROD KIT	BAJAJ PLATINA-125 / XCD-125 (002)	10
520AM00381	CONNECTING ROD KIT	BAJAJ PLATINA-125 / XCD-125 (003)	10
520AM00531	CONNECTING ROD KIT	BAJAJ PULSAR DIGITAL/150-UPG3/UPG4(STD)	10
520AM00532	CONNECTING ROD KIT	BAJAJ PULSAR DIGITAL/150-UPG3/UPG4(001)	10
520AM00533	CONNECTING ROD KIT	BAJAJ PULSAR DIGITAL/150-UPG3/UPG4(002)	10
520AM00534	CONNECTING ROD KIT	BAJAJ PULSAR DIGITAL/150-UPG3/UPG4(003)	10
520AM00554	CONNECTING ROD KIT	BAJAJ DISCOVER 135 CC (STD)	10
520AM00555	CONNECTING ROD KIT	BAJAJ DISCOVER 135 135 CC (001)	10
520AM00556	CONNECTING ROD KIT	BAJAJ DISCOVER 135 CC (002)	10
520AM00557	CONNECTING ROD KIT	BAJAJ DISCOVER 135 CC (003)	10
520AM00558	CONNECTING ROD KIT	BAJAJ DISCOVER 125 CC old (STD)	10

# CONNECTING ROD KIT

## CONNECTING ROD KIT - TWO WHEELER



**ENDURANCE**  
Complete Solutions

ETL PART NO	APPLICATION	SUITABLE FOR	STD PACKING
520AM00559	CONNECTING ROD KIT	BAJAJ DISCOVER 125 CC old (001)	10
520AM00560	CONNECTING ROD KIT	BAJAJ DISCOVER 125 CC old (002)	10
520AM00561	CONNECTING ROD KIT	BAJAJ DISCOVER 125 CC old (003)	10
520AM00597	CONNECTING ROD KIT	BAJAJ PULSAR-150AS (STD)	10
520AM00598	CONNECTING ROD KIT	BAJAJ PULSAR-150AS (001)	10
520AM00599	CONNECTING ROD KIT	BAJAJ PULSAR-150AS (002)	10
520AM00600	CONNECTING ROD KIT	BAJAJ PULSAR-150AS (003)	10
520AM00574	CONNECTING ROD KIT	BAJAJ DISCOVER 100M/100T (STD)	10
520AM00575	CONNECTING ROD KIT	BAJAJ DISCOVER 100M/100T (001)	10
520AM00576	CONNECTING ROD KIT	BAJAJ DISCOVER 100M/100T (002)	10
520AM00577	CONNECTING ROD KIT	BAJAJ DISCOVER 100M/100T (003)	10
520AM00281	CONNECTING ROD KIT	HONDA ACTIVA 100 (STD)	12
520AM00315	CONNECTING ROD KIT	HONDA ACTIVA 100 (001)	12
520AM00316	CONNECTING ROD KIT	HONDA ACTIVA 100 (002)	12
520AM00952	CONNECTING ROD KIT	HONDA ACTIVA 100 (003)	12
520AM00953	CONNECTING ROD KIT	HONDA ACTIVA 100 (004)	12
520AM00285	CONNECTING ROD KIT	HONDA SHINE(STD)	10
520AM00293	CONNECTING ROD KIT	HONDA SHINE (001)	10
520AM00955	CONNECTING ROD KIT	HONDA SHINE (002)	10
520AM00971	CONNECTING ROD KIT	HONDA SHINE (003)	10
520AM00527	CONNECTING ROD KIT	HONDA TWISTER/YUGA/NIO (STD)	10
520AM00528	CONNECTING ROD KIT	HONDA TWISTER/YUGA/NIO (001)	10
520AM00529	CONNECTING ROD KIT	HONDA TWISTER/YUGA/NIO (002)	10
520AM00530	CONNECTING ROD KIT	HONDA TWISTER/YUGA/NIO (003)	10
520AM00965	CONNECTING ROD KIT	HONDA ACTIVA HET (STD)	10
520AM00456	CONNECTING ROD KIT	HONDA ACTIVA HET (001)	10
520AM00457	CONNECTING ROD KIT	HONDA ACTIVA HET (002)	10
520AM00458	CONNECTING ROD KIT	HONDA ACTIVA HET (003)	10
520AM00549	CONNECTING ROD KIT	HONDA ACTIVA 110 (STD)	10
520AM00550	CONNECTING ROD KIT	HONDA ACTIVA 110 (001)	10
520AM00551	CONNECTING ROD KIT	HONDA ACTIVA 110 (002)	10
520AM00552	CONNECTING ROD KIT	HONDA ACTIVA 110 (003)	10
520AM00553	CONNECTING ROD KIT	HONDA ACTIVA 110 (004)	10
520AM00428	CONNECTING ROD KIT	HONDA UNICORN (STD)	10
520AM00429	CONNECTING ROD KIT	HONDA UNICORN (001)	10
520AM00430	CONNECTING ROD KIT	HONDA UNICORN (002)	10
520AM00431	CONNECTING ROD KIT	HONDA UNICORN (003)	10
520AM00280	CONNECTING ROD KIT	TVS CENTRA / STAR 100 (STD)	12
520AM00298	CONNECTING ROD KIT	TVS CENTRA / STAR 100 (001)	12
520AM00299	CONNECTING ROD KIT	TVS CENTRA / STAR 100 (002)	12
520AM00951	CONNECTING ROD KIT	TVS CENTRA / STAR 100 (003)	12
520AM00287	CONNECTING ROD KIT	TVS PEP + (STD)	12
520AM00303	CONNECTING ROD KIT	TVS PEP + (001)	12
520AM00304	CONNECTING ROD KIT	TVS PEP + (002)	12
520AM00382	CONNECTING ROD KIT	TVS STAR SPORTS / STAR-110 (STD)	10
520AM00383	CONNECTING ROD KIT	TVS STAR SPORTS / STAR-110 (001)	10
520AM00384	CONNECTING ROD KIT	TVS STAR SPORTS / STAR-110 (002)	10

# CONNECTING ROD KIT

## CONNECTING ROD KIT - TWO WHEELER



**ENDURANCE**  
Complete Solutions

ETL PART NO	APPLICATION	SUITABLE FOR	STD PACKING
520AM00385	CONNECTING ROD KIT	TVS STAR SPORTS / STAR-110 (003)	10
520AM00535	CONNECTING ROD KIT	TVS XL SUPER 70 CC (STD)	10
520AM00536	CONNECTING ROD KIT	TVS XL SUPER 70 CC (001)	10
520AM00537	CONNECTING ROD KIT	TVS XL SUPER 70 CC (002)	10
520AM00538	CONNECTING ROD KIT	TVS XL SUPER 70 CC (003)	10
520AM00539	CONNECTING ROD KIT	TVS XL SUPER 70 CC (004)	10
520AM00540	CONNECTING ROD KIT	TVS XL SUPER 70 CC (005)	10
520AM00541	CONNECTING ROD KIT	TVS XL SUPER 70 CC (006)	10
520AM00542	CONNECTING ROD KIT	TVS XL SUPER 70 CC (007)	10
520AM00543	CONNECTING ROD KIT	TVS XL SUPER 70 CC (008)	10
520AM00544	CONNECTING ROD KIT	TVS XL SUPER 70 CC (009)	10
520AM00545	CONNECTING ROD KIT	TVS XL SUPER 70 CC (010)	10
520AM00546	CONNECTING ROD KIT	TVS XL 100 CC (STD)	10
520AM00547	CONNECTING ROD KIT	TVS XL 100 CC (001)	10
520AM00548	CONNECTING ROD KIT	TVS XL 100 CC (002)	10
520AM00451	CONNECTING ROD KIT	TVS APACHE RTR 160/180/ TVS KNG (STD)	10
520AM00452	CONNECTING ROD KIT	TVS APACHE RTR 160/180/ TVS KNG (001)	10
520AM00453	CONNECTING ROD KIT	TVS APACHE RTR 160/180/ TVS KNG (002)	10
520AM00454	CONNECTING ROD KIT	TVS APACHE RTR 160/180/ TVS KNG (003)	10
520AM00562	CONNECTING ROD KIT	TVS VICTOR (STD)	10
520AM00563	CONNECTING ROD KIT	TVS VICTOR (001)	10
520AM00564	CONNECTING ROD KIT	TVS VICTOR (002)	10
520AM00565	CONNECTING ROD KIT	TVS VICTOR (003)	10
520AM00570	CONNECTING ROD KIT	TVS WEGO (STD)	10
520AM00571	CONNECTING ROD KIT	TVS WEGO (001)	10
520AM00572	CONNECTING ROD KIT	TVS WEGO (002)	10
520AM00573	CONNECTING ROD KIT	TVS WEGO (003)	10
520AM00566	CONNECTING ROD KIT	TVS FIERO (STD)	10
520AM00567	CONNECTING ROD KIT	TVS FIERO (001)	10
520AM00568	CONNECTING ROD KIT	TVS FIERO (002)	10
520AM00569	CONNECTING ROD KIT	TVS FIERO (003)	10
520AM00462	CONNECTING ROD KIT	SUZUKI HEAT/ACCESS old (STD)	10
520AM00463	CONNECTING ROD KIT	SUZUKI HEAT/ACCESS old (001)	10
520AM00464	CONNECTING ROD KIT	SUZUKI HEAT/ACCESS old (002)	10
520AM00590	CONNECTING ROD KIT	SUZUKI ACCESS NEW 125 CC (STD)	10
520AM00591	CONNECTING ROD KIT	SUZUKI ACCESS NEW 125 CC (001)	10
520AM00592	CONNECTING ROD KIT	SUZUKI ACCESS NEW 125 CC (002)	10
520AM00465	CONNECTING ROD KIT	SUZUKI GXR 150 (STD)	10
520AM00466	CONNECTING ROD KIT	SUZUKI GSR 150 (001)	10
520AM00467	CONNECTING ROD KIT	SUZUKI GSR 150 (002)	10
520AM00970	CONNECTING ROD KIT	SUZUKI GSR 150 (003)	10
520AM00582	CONNECTING ROD KIT	YAMAHA FZ (STD)	10
520AM00583	CONNECTING ROD KIT	YAMAHA FZ (001)	10
520AM00584	CONNECTING ROD KIT	YAMAHA FZ (002)	10
520AM00585	CONNECTING ROD KIT	YAMAHA FZ (003)	10
520AM00586	CONNECTING ROD KIT	YAMAHA CRUX (STD)	10
520AM00587	CONNECTING ROD KIT	YAMAHA CRUX (001)	10

# CONNECTING ROD KIT

## CONNECTING ROD KIT - TWO WHEELER



**ENDURANCE**  
Complete Solutions

ETL PART NO	APPLICATION	SUITABLE FOR	STD PACKING
520AM00588	CONNECTING ROD KIT	YAMAHA CRUX (002)	10
520AM00589	CONNECTING ROD KIT	YAMAHA CRUX (003)	10
520AM00438	CONNECTING ROD KIT	YAMAHA R15 (STD)	10
520AM00439	CONNECTING ROD KIT	YAMAHA R15 (001)	10
520AM00440	CONNECTING ROD KIT	YAMAHA R15 (002)	10
520AM00968	CONNECTING ROD KIT	YAMAHA R15 (003)	10
520AM00445	CONNECTING ROD KIT	YAMAHA YBX (STD)	10
520AM00446	CONNECTING ROD KIT	YAMAHA YBX (001)	10
520AM00447	CONNECTING ROD KIT	YAMAHA YBX (002)	10
520AM00966	CONNECTING ROD KIT	YAMAHA YBX (003)	10
520AM00448	CONNECTING ROD KIT	YAMAHA REY (STD)	10
520AM00449	CONNECTING ROD KIT	YAMAHA REY (001)	10
520AM00450	CONNECTING ROD KIT	YAMAHA REY (002)	10
520AM00459	CONNECTING ROD KIT	MAHINDRA DURO (STD)	12
520AM00460	CONNECTING ROD KIT	MAHINDRA DURO (001)	12
520AM00461	CONNECTING ROD KIT	MAHINDRA DURO (002)	12
520AM00961	CONNECTING ROD KIT	MAHINDRA DURO (003)	12

## CONNECTING ROD KIT - THREE WHEELER

520AM00279	CONNECTING ROD KIT	BAJAJ 3W4S (CNG) (STD)	10
520AM00311	CONNECTING ROD KIT	BAJAJ 3W4S (CNG) (001)	10
520AM00312	CONNECTING ROD KIT	BAJAJ 3W4S (CNG) (002)	10
520AM00313	CONNECTING ROD KIT	BAJAJ 3W4S (CNG) (003)	10
520AM00333	CONNECTING ROD KIT	BAJAJ 3W4S (CNG) (004)	10
520AM00334	CONNECTING ROD KIT	BAJAJ 3W4S (CNG) (005)	10
520AM00335	CONNECTING ROD KIT	BAJAJ 3W4S (CNG) (006)	10
520AM00336	CONNECTING ROD KIT	BAJAJ 3W4S (CNG) (007)	10
520AM00337	CONNECTING ROD KIT	BAJAJ 3W4S (CNG) (008)	10
520AM00338	CONNECTING ROD KIT	BAJAJ 3W4S (CNG) (009)	10
520AM00339	CONNECTING ROD KIT	BAJAJ 3W4S (CNG) (010)	10
520AM00523	CONNECTING ROD KIT	BAJAJ RE 3W2S (STD)	10
520AM00524	CONNECTING ROD KIT	BAJAJ RE 3W2S (001)	10
520AM00525	CONNECTING ROD KIT	BAJAJ RE 3W2S (002)	10
520AM00526	CONNECTING ROD KIT	BAJAJ RE 3W2S (003)	10
520AM00956	CONNECTING ROD KIT	BAJAJ RE 3W2S (004)	10
520AM00957	CONNECTING ROD KIT	BAJAJ RE 3W2S (005)	10
520AM00958	CONNECTING ROD KIT	BAJAJ RE 3W2S (006)	10
520AM00959	CONNECTING ROD KIT	BAJAJ RE 3W2S (007)	10
520AM00960	CONNECTING ROD KIT	BAJAJ RE 3W2S (008)	10



# Camshaft



1) 2WHEELER /  
3 WHEELER  
CAM SHAFT

## Parts of Camshaft

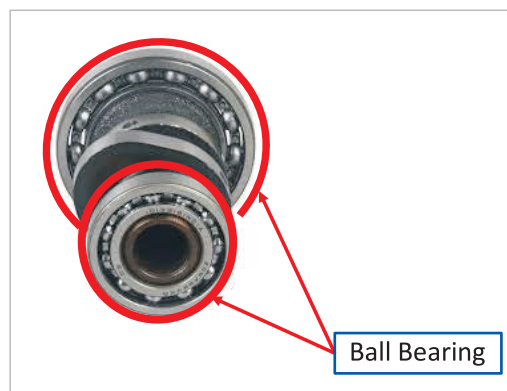
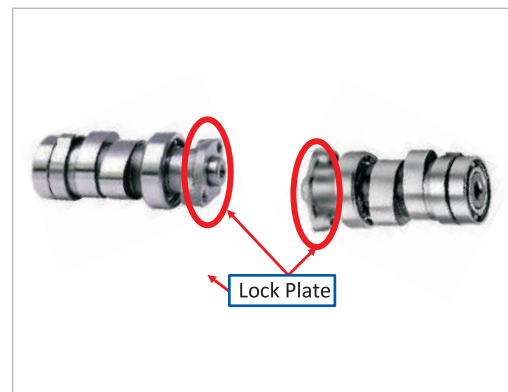
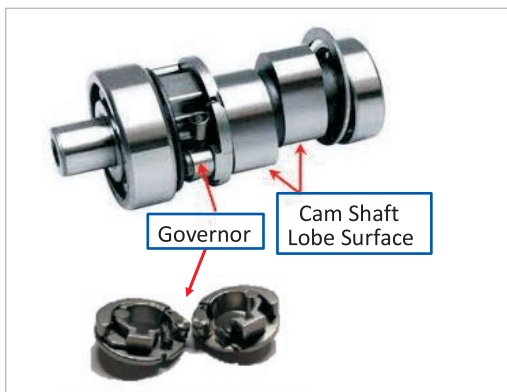

# CAMSHAFT

## CAMSHAFT TWO WHEELER



**ENDURANCE**  
Complete Solutions



**PART NO. :** 520AM00343  
**APPLICATION :** CAM SHAFT  
**SUITABLE FOR :** HERO CD/  
DAWN/SPLENDOR/  
SPLENDOR +  
**STD. PACK :** 10



**PART NO. :** 520AM00356  
**APPLICATION :** CAM SHAFT  
**SUITABLE FOR :** HERO CBZ/  
KARIZMA/AMBITION  
**STD. PACK :** 10



**PART NO. :** 520AM00364  
**APPLICATION :** CAM SHAFT  
**SUITABLE FOR :** HERO SPR  
SPLENDOR/GLAMOUR  
**STD. PACK :** 10



**PART NO. :** 520AM00368  
**APPLICATION :** CAM SHAFT  
**SUITABLE FOR :** HERO  
SPLENDOR NXG/PASSION PRO/  
CD DELUXE  
**STD. PACK :** 10



**PART NO. :** 520AM00344  
**APPLICATION :** CAM SHAFT  
**SUITABLE FOR :** BAJAJ KB-4S/  
BOXER/CALIBER  
**STD. PACK :** 10

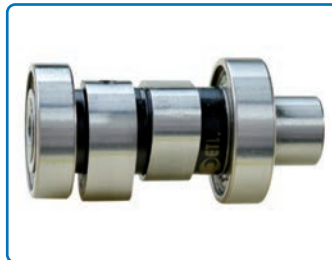

**PART NO. :** 520AM00359  
**APPLICATION :** CAM SHAFT  
**SUITABLE FOR :** BAJAJ CT-100  
**STD. PACK :** 10



**PART NO. :** 520AM00362  
**APPLICATION :** CAM SHAFT  
**SUITABLE FOR :** BAJAJ  
PLATINA  
**STD. PACK :** 10



**PART NO. :** 520AM00374  
**APPLICATION :** CAM SHAFT  
**SUITABLE FOR :** BAJAJ  
PLATINA-125  
**STD. PACK :** 10



**PART NO. :** 520AM00351  
**APPLICATION :** CAM SHAFT  
**SUITABLE FOR :** BAJAJ  
DISCOVER-100  
**STD. PACK :** 10



**PART NO. :** 520AM00375  
**APPLICATION :** CAM SHAFT  
**SUITABLE FOR :** BAJAJ  
XCD-125/135  
**STD. PACK :** 10



**PART NO. :** 520AM00352  
**APPLICATION :** CAM SHAFT  
**SUITABLE FOR :** BAJAJ  
DISCOVER-150  
**STD. PACK :** 10



**PART NO. :** 520AM00377  
**APPLICATION :** CAM SHAFT  
**SUITABLE FOR :** BAJAJ  
DISCOVER-100T  
**STD. PACK :** 10



**PART NO. :** 520AM00357  
**APPLICATION :** CAM SHAFT  
**SUITABLE FOR :** BAJAJ  
PULSAR DIGITAL  
**STD. PACK :** 10



**PART NO. :** 520AM00943  
**APPLICATION :** CAM SHAFT  
**SUITABLE FOR :** BAJAJ  
PULSAR 150 UPG3  
**STD. PACK :** 10



**PART NO. :** 520AM00944  
**APPLICATION :** CAM SHAFT  
**SUITABLE FOR :** BAJAJ  
PULSAR 150 UPG4  
**STD. PACK :** 10



**PART NO. :** 520AM00367  
**APPLICATION :** CAM SHAFT  
**SUITABLE FOR :** BAJAJ PULSAR  
-200/220/ DISCOVER DTSI/  
112/125/135  
**STD. PACK :** 10

# CAMSHAFT

## CAMSHAFT TWO WHEELER



**ENDURANCE**  
Complete Solutions



**PART NO. :** 520AM00370  
**APPLICATION :** CAM SHAFT  
**SUITABLE FOR :** BAJAJ  
PULSAR-150/180 DTSI  
**STD. PACK :** 10



**PART NO. :** 520AM00361  
**APPLICATION :** CAM SHAFT  
**SUITABLE FOR :** BAJAJ  
PULSAR-150/180  
**STD. PACK :** 10



**PART NO. :** 520AM00373  
**APPLICATION :** CAM SHAFT  
**SUITABLE FOR :** BAJAJ  
PULSAR-200NS  
**STD. PACK :** 10



**PART NO. :** 520AM00363  
**APPLICATION :** CAM SHAFT  
**SUITABLE FOR :** BAJAJ  
PULSAR-135LS/  
DISCOVER-125ST  
**STD. PACK :** 10



**PART NO. :** 520AM00342  
**APPLICATION :** CAM SHAFT  
**SUITABLE FOR :** HONDA  
ACTV/DIO/PLEASURE  
**STD. PACK :** 10



**PART NO. :** 520AM00346  
**APPLICATION :** CAM SHAFT  
**SUITABLE FOR :** HONDA UNCRN/  
SHN/CBZ XTRM/STNR/HNK  
**STD. PACK :** 10

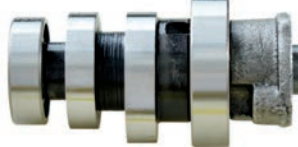

**PART NO. :** 520AM00369  
**APPLICATION :** CAM SHAFT  
**SUITABLE FOR :** HONDA  
TWISTER  
**STD. PACK :** 10



**PART NO. :** 520AM00376  
**APPLICATION :** CAM SHAFT  
**SUITABLE FOR :** HONDA  
ACTIVA-110/ HET  
**STD. PACK :** 10



**PART NO. :** 520AM00347  
**APPLICATION :** CAM SHAFT  
**SUITABLE FOR :** TVS VICTOR  
**STD. PACK :** 10



**PART NO. :** 520AM00348  
**APPLICATION :** CAM SHAFT  
**SUITABLE FOR :** TVS STAR/  
SCOOTY PEP/SCOOTY PEP  
PLUS  
**STD. PACK :** 10



**PART NO. :** 520AM00371  
**APPLICATION :** CAM SHAFT  
**SUITABLE FOR :** TVS CENTRA/  
STAR CTY  
**STD. PACK :** 10



**PART NO. :** 520AM00436  
**APPLICATION :** CAM SHAFT  
**SUITABLE FOR :** TVS STAR  
SPORTS  
**STD. PACK :** 10



**PART NO. :** 520AM00354  
**APPLICATION :** CAM SHAFT  
**SUITABLE FOR :** TVS APACHE  
RTR/APACHE 160/180  
**STD. PACK :** 10



**PART NO. :** 520AM00345  
**APPLICATION :** CAM SHAFT  
**SUITABLE FOR :** SUZUKI  
ACCESS  
**STD. PACK :** 10



**PART NO. :** 520AM00366  
**APPLICATION :** CAM SHAFT  
**SUITABLE FOR :** SUZUKI  
HEAT/ZEUS  
**STD. PACK :** 10



**PART NO. :** 520AM00360  
**APPLICATION :** CAM SHAFT  
**SUITABLE FOR :** YAMAHA CRUX/  
YBX/LIBERO/ENTICER/FZR  
**STD. PACK :** 10

# CAMSHAFT

## CAMSHAFT TWO WHEELER



**PART NO. :** 520AM00441  
**APPLICATION :** CAM SHAFT  
**SUITABLE FOR :** YAMAHA FZ  
**STD. PACK :** 10



**PART NO. :** 520AM00442  
**APPLICATION :** CAM SHAFT  
**SUITABLE FOR :** YAMAHA R-15  
**STD. PACK :** 10

## CAM SHAFT - THREE WHEELER

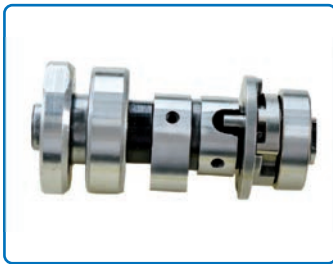

**PART NO. :** 520AM00349  
**APPLICATION :** CAM SHAFT  
**SUITABLE FOR :** BAJAJ  
CNG-175/145 4S  
**STD. PACK :** 10



**PART NO. :** 520AM00350  
**APPLICATION :** CAM SHAFT  
**SUITABLE FOR :** BAJAJ  
CNG-225/COMPACT 4S  
**STD. PACK :** 10



**PART NO. :** 520AM01404  
**APPLICATION :** CAM SHAFT  
**SUITABLE FOR :** BAJAJ  
CNG-225/COMPACT 4S  
(AFTER 2017)  
**STD. PACK :** 10

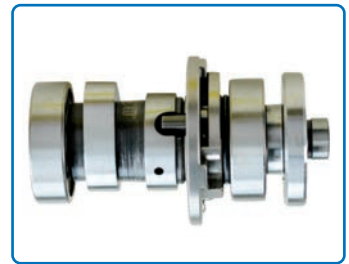

**PART NO. :** 520AM00437  
**APPLICATION :** CAM SHAFT  
**SUITABLE FOR :** TVS KNG  
**STD. PACK :** 10

# Rocker Arm

2) 2WHEELER /  
3 WHEELER  
ROCKER ARM



## Parts of Rocker Arm

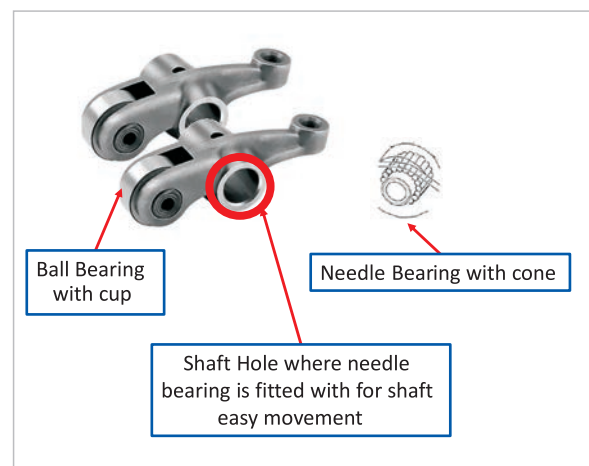

# ROCKER ARM

## ROCKER ARM - TWO WHEELER



**ENDURANCE**  
Complete Solutions



**PART NO. :** 520AM00414  
**APPLICATION :** ROCKER ARM  
**SUITABLE FOR :** HERO  
CD-100/SPLENDOR/PASSION  
**STD. PACK :** 10



**PART NO. :** 520AM00435  
**APPLICATION :** ROCKER ARM  
**SUITABLE FOR :** HERO SUPER  
SPLENDOR/GLAMOUR  
**STD. PACK :** 10



**PART NO. :** 520AM00915  
**APPLICATION :** ROCKER ARM  
**SUITABLE FOR :** HERO  
SPLENDOR NXG/CD-DLX  
**STD. PACK :** 10



**PART NO. :** 520AM00415  
**APPLICATION :** ROCKER ARM  
**SUITABLE FOR :** HERO  
CBZ/AMBITION/KARIZMA  
**STD. PACK :** 10



**PART NO. :** 520AM00398  
**APPLICATION :** ROCKER ARM  
**SUITABLE FOR :** BAJAJ  
KB4S/BOXER/CALIBER  
**STD. PACK :** 10



**PART NO. :** 520AM00395  
**APPLICATION :** ROCKER ARM  
**SUITABLE FOR :** BAJAJ CT-100  
**STD. PACK :** 10



**PART NO. :** 520AM00904  
**APPLICATION :** ROCKER ARM  
**SUITABLE FOR :** BAJAJ  
PLATINA/CT-100 DLX/  
DISCOVER-112  
**STD. PACK :** 10



**PART NO. :** 520AM00905  
**APPLICATION :** ROCKER ARM  
**SUITABLE FOR :** BAJAJ  
PLATINA-125/XCD-125/  
DISCOVER-100/XCD-135  
**STD. PACK :** 10



**PART NO. :** 520AM00906  
**APPLICATION :** ROCKER ARM  
**SUITABLE FOR :** BAJAJ PULSAR-  
DTSI/UPG3/UPG4/200/220  
DTSI/DISCOVER-135/  
DISCOVER DTSI  
**STD. PACK :** 10



**PART NO. :** 520AM00907  
**APPLICATION :** ROCKER ARM  
**SUITABLE FOR :** BAJAJ  
PULSAR-150/180 DTSI  
**STD. PACK :** 10



**PART NO. :** 520AM00908  
**APPLICATION :** ROCKER ARM  
**SUITABLE FOR :** BAJAJ  
PULSAR 150/180  
**STD. PACK :** 10



**PART NO. :** 520AM00400  
**APPLICATION :** ROCKER ARM  
**SUITABLE FOR :** BAJAJ  
PULSAR-135 LS  
**STD. PACK :** 10



**PART NO. :** 520AM00911  
**APPLICATION :** ROCKER ARM  
**SUITABLE FOR :** BAJAJ  
DISCOVER-125ST  
**STD. PACK :** 10



**PART NO. :** 520AM00912  
**APPLICATION :** ROCKER ARM  
**SUITABLE FOR :** BAJAJ  
DISCOVER-100T  
**STD. PACK :** 10



**PART NO. :** 520AM00404  
**APPLICATION :** ROCKER ARM  
**SUITABLE FOR :** BAJAJ  
PULSAR-200NS/AS  
**STD. PACK :** 10

# ROCKER ARM

## ROCKER ARM - TWO WHEELER



**ENDURANCE**  
Complete Solutions



**PART NO. :** 520AM00923  
**APPLICATION :** ROCKER ARM  
**SUITABLE FOR :** YAMAHA R-15  
**STD. PACK :** 10



**PART NO. :** 520AM00913  
**APPLICATION :** ROCKER ARM  
**SUITABLE FOR :** BAJAJ  
DISCOVER-150  
**STD. PACK :** 10



**PART NO. :** 520AM00413  
**APPLICATION :** ROCKER ARM  
**SUITABLE FOR :** HONDA  
ACTIVA/DIO/HERO PLEASURE  
**STD. PACK :** 10



**PART NO. :** 520AM00408  
**APPLICATION :** ROCKER ARM  
**SUITABLE FOR :** HONDA  
ACTIVA-110  
**STD. PACK :** 10



**PART NO. :** 520AM00405  
**APPLICATION :** ROCKER ARM  
**SUITABLE FOR :** HONDA  
TWISTER  
**STD. PACK :** 10



**PART NO. :** 520AM00406  
**APPLICATION :** ROCKER ARM  
**SUITABLE FOR :** HONDA  
UNICORN/SHINE/HERO  
CBZ XTRME/HUNK/ACHEIVER  
**STD. PACK :** 10



**PART NO. :** 520AM00411  
**APPLICATION :** ROCKER ARM  
**SUITABLE FOR :** TVS VICTOR/  
STAR  
**STD. PACK :** 10



**PART NO. :** 520AM00412  
**APPLICATION :** ROCKER ARM  
**SUITABLE FOR :** TVS STAR CTY/  
CENTRA  
**STD. PACK :** 10



**PART NO. :** 520AM00416  
**APPLICATION :** ROCKER ARM  
**SUITABLE FOR :** TVS  
APACHE-160/180 RTR/WEGO/  
JUPITOR  
**STD. PACK :** 10



**PART NO. :** 520AM00918  
**APPLICATION :** ROCKER ARM  
**SUITABLE FOR :** TVS SCOOTY  
PEP  
**STD. PACK :** 10



**PART NO. :** 520AM00919  
**APPLICATION :** ROCKER ARM  
**SUITABLE FOR :** TVS SCOOTY  
PEP PLUS  
**STD. PACK :** 10



**PART NO. :** 520AM00924  
**APPLICATION :** ROCKER ARM  
**SUITABLE FOR :** SUZUKI  
HEAT/ZEUS  
**STD. PACK :** 10



**PART NO. :** 520AM00418  
**APPLICATION :** ROCKER ARM  
**SUITABLE FOR :** SUZUKI  
ACCESS  
**STD. PACK :** 10



**PART NO. :** 520AM00920  
**APPLICATION :** ROCKER ARM  
**SUITABLE FOR :** YAMAHA YBX/  
CRX/ENTICER/LIBERO/  
FAZER OLD  
**STD. PACK :** 10



**PART NO. :** 520AM00921  
**APPLICATION :** ROCKER ARM  
**SUITABLE FOR :** YAMAHA FZ/  
FZ-1/FAZER NEW MODEL  
**STD. PACK :** 10



**PART NO. :** 520AM00922  
**APPLICATION :** ROCKER ARM  
**SUITABLE FOR :** YAMAHA RAY/  
ALPHA/FASCINO  
**STD. PACK :** 10

# ROCKER ARM

## ROCKER ARM-THREE WHEELER



**PART NO. :** 520AM00398  
**APPLICATION :** ROCKER ARM  
**SUITABLE FOR :** BAJAJ  
CNG-175/205  
**STD. PACK :** 10



**PART NO. :** 520AM00396  
**APPLICATION :** ROCKER ARM  
**SUITABLE FOR :** BAJAJ  
COMPACT-225  
**STD. PACK :** 10



**PART NO. :** 520AM00416  
**APPLICATION :** ROCKER ARM  
**SUITABLE FOR :** TVS KNG  
**STD. PACK :** 10



# ROCKER ARM

## ROCKER ARM WITH SCREW



ETL PART NO.	DESCRIPTION	APPLICABLE	STD. PACK
520AM01532	ROCKER ARM WITH SCREW	HERO CD-100/SPLENDOR/PSSN	10
520AM01533	ROCKER ARM WITH SCREW	HERO SUPER SPLENDOR /GLAMOUR	10
520AM01534	ROCKER ARM WITH SCREW	HERO SPLENDOR NXG/CD-DLX	10
520AM01535	ROCKER ARM WITH SCREW	HONDA ACTIVA/PLEASURE/DIO	10
520AM01536	ROCKER ARM WITH SCREW	HERO CBZ	10
520AM01537	ROCKER ARM WITH SCREW	HONDA ACTIVA-110	10
520AM01538	ROCKER ARM WITH SCREW	HONDA TWISTER	10
520AM01539	ROCKER ARM WITH SCREW	HONDA UNICORN/SHINE/HERO HUNK/ACHEIVER	10
520AM01541	ROCKER ARM WITH SCREW	BAJAJ KB4S/BOXER/CALIBER	10
520AM01540	ROCKER ARM WITH SCREW	BAJAJ CT-100	10
520AM01542	ROCKER ARM WITH SCREW	BAJAJ PLATINA/DISCOVER-112	10
520AM01543	ROCKER ARM WITH SCREW	BAJAJ PLATINA125/XCD125/135	10
520AM01544	ROCKER ARM WITH SCREW	BAJAJ CNG-175/205	10
520AM01545	ROCKER ARM WITH SCREW	BAJAJ COMPCT-225/DISCOVER	10
520AM01546	ROCKER ARM WITH SCREW	BAJAJ PULSAR-DTSI/UPG3-G4	10
520AM01547	ROCKER ARM WITH SCREW	BAJAJ PULSAR-150/180 DTSI	10
520AM01548	ROCKER ARM WITH SCREW	BAJAJ PULSAR 150/180	10
520AM01549	ROCKER ARM WITH SCREW	BAJAJ PULSAR-135LS	10
520AM01550	ROCKER ARM WITH SCREW	BAJAJ DISCOVER-125ST	10
520AM01551	ROCKER ARM WITH SCREW	BAJAJ DISCOVER-100T	10
520AM01553	ROCKER ARM WITH SCREW	BAJAJ PULSAR-200NS/AS	10
520AM01555	ROCKER ARM WITH SCREW	BAJAJ DISCOVER-150	10
520AM01556	ROCKER ARM WITH SCREW	TVS VICTOR/STAR	10
520AM01557	ROCKER ARM WITH SCREW	TVS STAR CITY/CENTRA	10
520AM01558	ROCKER ARM WITH SCREW	TVS APACHE-160/180/KING	10
520AM01559	ROCKER ARM WITH SCREW	TVS SCOOTY PEP	10
520AM01560	ROCKER ARM WITH SCREW	TVS SCOOTY PEP PLUS	10
520AM01561	ROCKER ARM WITH SCREW	YAMAHA YBX/CRUX/FAZER OLD	10
520AM01562	ROCKER ARM WITH SCREW	YAMAHA FZ/FZ-1/FAZER NEW	10
520AM01563	ROCKER ARM WITH SCREW	YAMAHA RAY/ALPHA/FASCINO	10
520AM01564	ROCKER ARM WITH SCREW	YAMAHA R-15	10
520AM01565	ROCKER ARM WITH SCREW	SUZUKI HEAT/ZEUS	10
520AM01566	ROCKER ARM WITH SCREW	SUZUKI ACCESS	10

# Wheel Rim



ETL PART NO	APPLICATION	SUITABLE FOR	STD. PACK
520AM01512	Motorcycle Wheel Rim 2.75X18	HERO CD 100,SPLENDOR,PASSION, YAMAHA CRUX, TVS CENTRA, MAX 100, HONDA SHINE, UNICORN	8
520AM01513	Motorcycle Wheel Rim 3X17 RR	DISCOVER DTSI 112, 125, 135, CT100, XCD125/135, PULSAR DTSI 150/180	8
520AM01514	Motorcycle Wheel Rim 2.75 X17 FR	DISCOVER DTSI 112, 125, 135, CT100, XCD125/135, PULSAR DTSI 150/180	8
520AM01515	Wheel Rim 2.5 X16	TVS XL HEAVY DUTY	8

# Silencer



# SILENCER



**PART NO. : 520AM01700**  
**APPLICATION : SILENCER**  
**SUITABLE FOR : HERO CD 100**  
**STD. PACK : 2**



**PART NO. : 520AM01701**  
**APPLICATION : SILENCER**  
**SUITABLE FOR : HERO SS 100**  
**STD. PACK : 2**



**PART NO. : 520AM01681**  
**APPLICATION : SILENCER**  
**SUITABLE FOR : HERO**  
**SPLENDOR**  
**STD. PACK : 2**



**PART NO. : 520AM01711**  
**APPLICATION : SILENCER**  
**SUITABLE FOR : HONDA**  
**ACTIVA OLD BLACK**  
**STD. PACK : 2**



**PART NO. : 520AM01682**  
**APPLICATION : SILENCER**  
**SUITABLE FOR : HERO**  
**SPLENDOR Y2K**  
**STD. PACK : 2**



**PART NO. : 520AM01712**  
**APPLICATION : SILENCER**  
**SUITABLE FOR : HONDA**  
**ACTIVA NEW BLACK**  
**STD. PACK : 2**



**PART NO. : 520AM01705**  
**APPLICATION : SILENCER**  
**SUITABLE FOR : HERO**  
**PASSION**  
**STD. PACK : 2**



**PART NO. : 520AM01715**  
**APPLICATION : SILENCER**  
**SUITABLE FOR : YAMAHA**  
**RX 100**  
**STD. PACK : 2**



**PART NO. : 520AM01718**  
**APPLICATION : SILENCER**  
**SUITABLE FOR : BJ KB 4S**  
**CHAMION**  
**STD. PACK : 2**



**PART NO. : 520AM01707**  
**APPLICATION : SILENCER**  
**SUITABLE FOR : HERO SUPER**  
**SPLENDOR BLACK**  
**STD. PACK : 2**



**PART NO. : 520AM01709**  
**APPLICATION : SILENCER**  
**SUITABLE FOR : HERO**  
**GLAMOUR**  
**STD. PACK : 2**



**PART NO. : 520AM01685**  
**APPLICATION : SILENCER**  
**SUITABLE FOR : HERO**  
**PASSION PRO BLACK**  
**STD. PACK : 2**



**PART NO. : 520AM01710**  
**APPLICATION : SILENCER**  
**SUITABLE FOR : HERO**  
**SPLENDOR PLUS**  
**STD. PACK : 2**



**PART NO. : 520AM01683**  
**APPLICATION : SILENCER**  
**SUITABLE FOR : HERO CD**  
**DELUXE CHEROME BLACK**  
**STD. PACK : 2**



**PART NO. : 520AM01684**  
**APPLICATION : SILENCER**  
**SUITABLE FOR : HERO**  
**SPLENDOR PRO BLACK**  
**STD. PACK : 2**



**PART NO. : 520AM01726**  
**APPLICATION : SILENCER**  
**SUITABLE FOR : BJ PLATINA 125**  
**CAT CONVERTER BLACK**  
**STD. PACK : 2**

# SILENCER

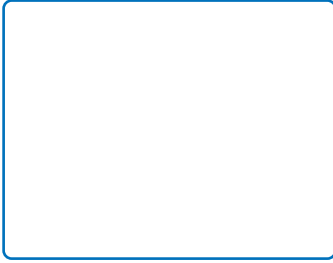

**PART NO. :** 520AM01692  
**APPLICATION :** SILENCER  
**SUITABLE FOR :** BJ PULSAR  
DTSI 150 CAT CONVERTER  
**STD. PACK :** 2

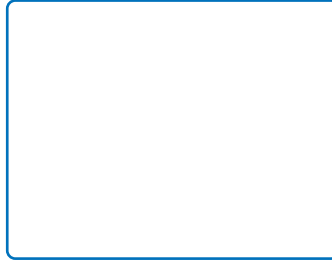

**PART NO. :** 520AM01689  
**APPLICATION :** SILENCER  
**SUITABLE FOR :** BJ DISCOVER  
125 CAT CONVERTER  
**STD. PACK :** 2

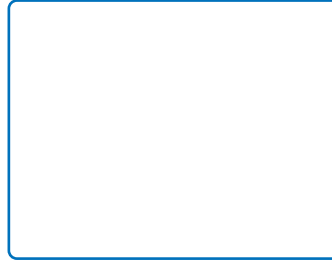

**PART NO. :** 520AM01690  
**APPLICATION :** SILENCER  
**SUITABLE FOR :** BJ DISCOVER  
125 CAT CONVERTER BLACK  
**STD. PACK :** 2

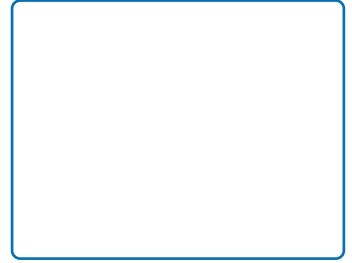

**PART NO. :** 520AM01694  
**APPLICATION :** SILENCER  
**SUITABLE FOR :** BJ PULSAR DTSI  
180 CAT CONVERTER BLACK  
**STD. PACK :** 2



**PART NO. :** 520AM01693  
**APPLICATION :** SILENCER  
**SUITABLE FOR :** BJ PULSAR DTSI  
150 CAT CONVERTER BLACK  
**STD. PACK :** 2



**PART NO. :** 520AM01686  
**APPLICATION :** SILENCER  
**SUITABLE FOR :** BJ CT 100  
**STD. PACK :** 2



**PART NO. :** 520AM01687  
**APPLICATION :** SILENCER  
**SUITABLE FOR :** BAJAJ DISCOVER  
112 CAT CONV BLACK  
**STD. PACK :** 2

# HORN



**PART NO. :** 520AM02374  
**APPLICATION :** BUZZER  
**SUITABLE FOR :** UNIVERSAL  
**STD. PACK :** 64



**PART NO. :** 520AM02375  
**APPLICATION :** HORN D-72  
MM (HT)  
**SUITABLE FOR :** UNIVERSAL  
**STD. PACK :** 60



**PART NO. :** 520AM02376  
**APPLICATION :** HORN D-72  
MM SET  
**SUITABLE FOR :** UNIVERSAL  
**STD. PACK :** 30



**PART NO. :** 520AM02377  
**APPLICATION :** HORN D-72  
MM (HT) PLSR TYPE  
**SUITABLE FOR :** UNIVERSAL  
**STD. PACK :** 60



**PART NO. :** 520AM02378  
**APPLICATION :** HORN D-72 MM  
SET PLSR TYPE  
**SUITABLE FOR :** UNIVERSAL  
**STD. PACK :** 30



**PART NO. :** 520AM02379  
**APPLICATION :** HORN D-72 MM  
(CNG) (HT)  
**SUITABLE FOR :** UNIVERSAL  
**STD. PACK :** 60



**PART NO. :** 520AM02380  
**APPLICATION :** HORN D-82  
MM (HT)  
**SUITABLE FOR :** UNIVERSAL  
**STD. PACK :** 60

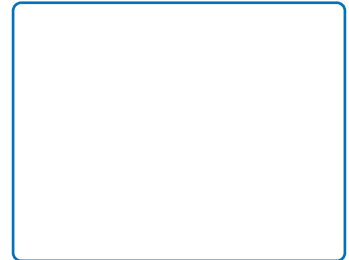

**PART NO. :** 520AM02381  
**APPLICATION :** HORN D-82  
MM SET  
**SUITABLE FOR :** UNIVERSAL  
**STD. PACK :** 30

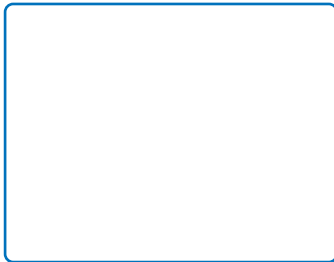

**PART NO. :** 520AM02382  
**APPLICATION :** HORN D-90 MM  
(BLACK) (HT)  
**SUITABLE FOR :** UNIVERSAL  
**STD. PACK :** 20



**PART NO. :** 520AM02383  
**APPLICATION :** HORN D-90 MM  
(BLACK) SET  
**SUITABLE FOR :** UNIVERSAL  
**STD. PACK :** 20

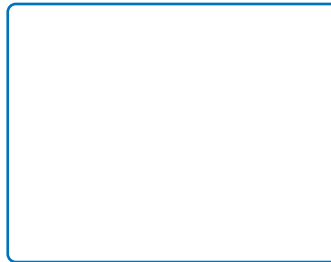

**PART NO. :** 520AM02384  
**APPLICATION :** HORN D-95 MM  
(CHROME) (HT)  
**SUITABLE FOR :** UNIVERSAL  
**STD. PACK :** 20



**PART NO. :** 520AM02385  
**APPLICATION :** HORN D-95 MM  
(CHROME) SET  
**SUITABLE FOR :** UNIVERSAL  
**STD. PACK :** 20

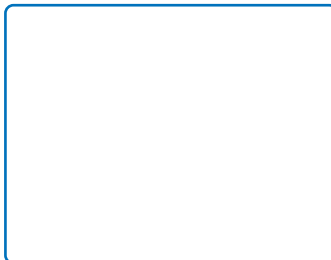

**PART NO. :** 520AM02386  
**APPLICATION :** HORN D-95 MM  
(YELLOW) (HT)  
**SUITABLE FOR :** UNIVERSAL  
**STD. PACK :** 20

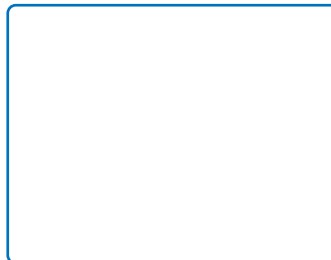

**PART NO. :** 520AM02387  
**APPLICATION :** HORN D-95 MM  
(YELLOW) SET  
**SUITABLE FOR :** UNIVERSAL  
**STD. PACK :** 20

# GENUINE OIL



**PART NO. :** 520AM02191  
**APPLICATION :** GENUINE OIL  
 20W-40 SL/MA2 - 900 ML  
**SUITABLE FOR :** UNIVERSAL  
**STD. PACK :** 20



**PART NO. :** 520AM02192  
**APPLICATION :** GENUINE OIL  
 20W-40 SL/MA2- 1L  
**SUITABLE FOR :** UNIVERSAL  
**STD. PACK :** 20



**PART NO. :** 520AM02193  
**APPLICATION :** GENUINE OIL  
 10W-30 SL/MB2 - 800 ML  
**SUITABLE FOR :** UNIVERSAL  
**STD. PACK :** 20



**PART NO. :** 520AM02194  
**APPLICATION :** GENUINE OIL  
 10W-30 SL/MA2 - 900 ML  
**SUITABLE FOR :** UNIVERSAL  
**STD. PACK :** 20

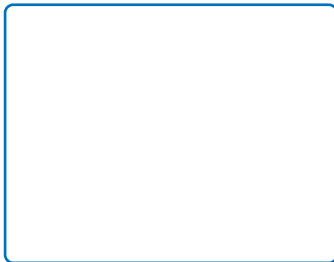

**PART NO. :** 520AM02195  
**APPLICATION :** GENUINE OIL  
 10W-30 SL/MA2 - 1L  
**SUITABLE FOR :** UNIVERSAL  
**STD. PACK :** 20



**PART NO. :** 520AM02196  
**APPLICATION :** GENUINE OIL  
 20W-50 SL/MA2 - 1.2 L  
**SUITABLE FOR :** UNIVERSAL  
**STD. PACK :** 20



**PART NO. :** 520AM02185  
**APPLICATION :** GENUINE OIL  
 20W-40 SN/MA2 -900 ML  
**SUITABLE FOR :** UNIVERSAL  
**STD. PACK :** 20



**PART NO. :** 520AM02186  
**APPLICATION :** GENUINE OIL  
 20W-40 SN/MA2 - 1L  
**SUITABLE FOR :** UNIVERSAL  
**STD. PACK :** 20



**PART NO. :** 520AM02188  
**APPLICATION :** GENUINE OIL  
 10W-30 SN/MA2 - 900 ML  
**SUITABLE FOR :** UNIVERSAL  
**STD. PACK :** 20



**PART NO. :** 520AM02189  
**APPLICATION :** GENUINE OIL  
 10W-30 SN/MA2 - 1L  
**SUITABLE FOR :** UNIVERSAL  
**STD. PACK :** 20



**PART NO. :** 520AM02187  
**APPLICATION :** GENUINE OIL  
 20W-50 SN/MA2 - 1.2L  
**SUITABLE FOR :** UNIVERSAL  
**STD. PACK :** 20



**PART NO. :** 520AM02190  
**APPLICATION :** GENUINE OIL  
 15W-50 SN/MA2 - 2.5L  
**SUITABLE FOR :** UNIVERSAL  
**STD. PACK :** 6



**PART NO. :** 520AM02199  
**APPLICATION :** GENUINE OIL  
 15W-40 CH-4 - 3L  
**SUITABLE FOR :** UNIVERSAL  
**STD. PACK :** 6



**PART NO. :** 520AM02200  
**APPLICATION :** GENUINE OIL  
 15W-40 CF-4 - 3L  
**SUITABLE FOR :** UNIVERSAL  
**STD. PACK :** 6



**PART NO. :** 520AM02197  
**APPLICATION :** GENUINE OIL  
 20W-50 SF/CD (Pouch) - 1L  
**SUITABLE FOR :** UNIVERSAL  
**STD. PACK :** 10



**ENDURANCE**  
*Complete Solutions*